



# neoX<sup>SR</sup>

BY PULSEEIGHT



---

# USER MANUAL

---

P8-HDBT2-U-FFMJ66-KIT

**HDMI** **eHDBT** **HDCP2.3** **amazon alexa**

## CONTENTS

Introduction . . . . .	3
Features . . . . .	3
Inside The Box (Kit) . . . . .	3
Specifications . . . . .	4
Safety Precaution . . . . .	5
Panel Descriptions . . . . .	6
Infrared Blaster Cable Pack . . . . .	8
neo:UltraSR Receiver . . . . .	8
HDBaseT Cabling . . . . .	9
IR Pin Assignments . . . . .	10
Installation . . . . .	11
IR Receiver And Transmitter Ports . . . . .	15
Wiring Guidelines . . . . .	16
neo Web Interface . . . . .	17
Monitoring Portal . . . . .	28
EDID Management . . . . .	32
IR Blasting . . . . .	34
Linked Device . . . . .	34
Updating Matrix Firmware . . . . .	38
Troubleshooting . . . . .	40
Supported 4K Resolutions . . . . .	43
Manual Version History . . . . .	43
Warranty Procedure . . . . .	44
Warranty Terms & Conditions . . . . .	45
Notes . . . . .	47

## INTRODUCTION

The neo:XSR is a 6x6 HDMI®/HDBaseT video matrix switch and the perfect product for routing multiple 4K UHD source devices to multiple locations within your environment. Supporting HDMI® 2.0 a/b, the latest HDCP 2.3 and 18Gbps bandwidth this is a must-have product in any residential multi-room control system integrating with the latest 4K UHD media devices.

The Pulse-Eight neo:XSR Video & Audio Matrix has it all - with multiple video inputs and both video and audio outputs. Featuring 6 HDMI® inputs, 4 HDBaseT Outputs and 2 HDMI® outputs alongside 6 audio output zones (with the options of Optical and Digital Coax). The neo:XSR goes the distance, supporting up to full 4K/60, 4:4:4, 8bit or 4K/60 4:2:2, 12bit up to 40 meters (130 feet). With audio breakout, Dolby Digital compliance and support for multiple video control methods.

## FEATURES

- Ultra HD 4K 60Hz 4:4:4 Video Transmission (up to 600Mhz)
- Latest HDCP 2.3 Support
- 6 x HDMI® Inputs
- 4 x HDBaseT Class C + DSC Outputs
- 2 x HDMI® Outputs
- 6 x Audio Output Zones
- HDMI® ARC
- IR Blasting feature
- HDMI-CEC Bi-Directional Control
- Alexa Voice Control
- Responsive Web Interface
- 10/100 Ethernet for 3rd party control and connection

## INSIDE THE BOX (KIT)

- 1 x neo:XSR Chassis
- 1 x Rack Mounting Kit
- 1 x IR Blaster Cable Pack
- 1 x Power Cord
- 1 x Quick Start Guide



neo:XSR



Quick Setup Guide



Power Cord



IR Blaster Cable Pack



Rack Mounting Kit

## SPECIFICATIONS

Video Resolution	All 4K formats *, 1080p, 1080i, 720p, 576p, 480p @24/25/30/50/59.94/60Hz. (* 4K resolution limited to 3840 x 2160 over HDBT)
Video Inputs	6 x HDMI®
Video Outputs	4 x HDBaseT + 2 HDMI® (6 switchable outputs)
HDMI® Compliance	HDMI® 2.0
HDCP Compliance	Up to 2.3
Input TMDS Signal	6Gbps per data lane (18Gbps total)
Bandwidth	18.0 Gbps
CEC	Yes - Bidirectional
Extender Technology	HDBaseT 2.0 (PoH compliant)
HDBaseT Connections	4
Transmission Distance	4K up to 40m (130ft) and 1080p up to 70m (230ft)
Chroma Subsampling	YCbCr4:4:4, YCbCr4:2:2, YCbCr4:2:0, RGB
Colorspace	YUV (rec. 601, rec709, rec2020), RGB
Color Depth	8-bit, 10-bit, 12-bit
Video Features	HDR10/HLG @ 60Hz and Dolby® Vision™ @ 30Hz
Audio Output Connectors	6 x digital coax, 6 x optical
IR Inputs to Room	Yes
IR Outputs to Source	Yes (Sources connected to inputs 1-4 only)
Ethernet Ports	1 x RJ45 (control only)
Available On Internet	Yes, thru the Pulse-Eight's Remote Monitoring Portal
RS-232 Ports	None
LED Indicators	Front - 3 LEDs (System Health , Network, Cloud Monitoring) Back - Various (port and signal connectivity status)
Operating Humidity	5 to 90% RH (no condensation)
Operating Temperature	0 to +35°C (32 to +95°F)
Storage Temperature	-20°C to 60°C (-4°F to 140°F)
Power Input	IEC C14 socket
Power Rating	100-240V, 4.0/2.0A, 50/60Hz
Surge Protection	AC Input : IEC61000-4-5 (class 3).
Rack Spacing	2U
Certifications	UKCA, CE, FCC (SDoC), RoHS
ESD Protection	Human Body Model: 15kV air, 8kV contact
Included Accessories	Rack mounting accessories, Power cable.
Drivers	Control 4. Others available – please enquire.
Dimensions (W x H x D)	17.32" x 12.44" x 3.50"
Weight	8.65 lb
Box Dimensions	22.83" x 14.72" x 5.12"

## SAFETY PRECAUTION

**Please read the instructions before attempting to install or operate this equipment.**

**Please keep the following in mind as you unpack and install this equipment:**

- Always follow basic safety precautions to reduce the risk of fire, electrical shock, and injury.
- To prevent fire or shock hazards, do not expose the unit to rain, or moisture or install this product near water.
- Never spill liquid of any kind on or into this product.
- Please use the included mounting kit where applicable, avoid blocking any vents on the product and follow best practices in rack design to help avoid overheating.
- Only use the supplied IEC cable.
- Never push any objects into this product through any openings or empty slots in the unit as you may damage parts inside and/or cause an electrical shock.
- Do not allow anything to rest on the power cabling and avoid putting the weight of any kind on it.
- To protect the unit from overheating do not block any vents or openings in the unit housing that provides ventilation. Allow sufficient space for air to circulate around the unit.
- This product is intended for use in a clean (dust-free) residential environment.

### Ventilation

It's important to keep the product well ventilated when installing this Pulse-Eight matrix.

Any electronic equipment will generate heat. A well-ventilated area helps to disperse the heat. If placed in a poorly ventilated area, your equipment may heat up and cause irreparable damage to the circuitries.

Allowing systems to run for prolonged periods under high temperatures will break down circuitry and electrical component. It also applies if the device is left in the path of direct sunlight or near any heat source.

Dust tends to accumulate and will disrupt the fan and electronics system. Dust particles contain various compositions like water, oil, and other minerals or chemicals. Having them in your electronic device can sometimes cause a signal error or degradation to the internal chips and circuitries. Because we cannot accurately predict how or when they can affect your device, we highly recommend that you keep Pulse-Eight products not only in a well-ventilated area but also as clean as possible.

In some cases, insects or reptiles can make nests near or inside the electronic casing. Whilst we design our products to maximize the protection of internal electronics, please be aware that insects and reptiles can be drawn to these types of habitats. In the unlikely event, this does happen, this will lead to poor ventilation inside the unit, and it will be unable to disperse heat effectively.

Finally, whenever possible, do not stack audio and video matrixes together. Leave enough space in between each unit in order to provide good airflow.

#### FCC Warning

This equipment has been tested and found to comply with the limits for a Class B digital device, pursuant to part 15 of the FCC Rules. These limits are designed to provide reasonable protection against harmful interference in a residential installation. This equipment generates, uses and can radiate radio frequency energy and, if not installed and used in accordance with the instructions, may cause harmful interference to radio communications. However, there is no guarantee that interference will not occur in a particular installation. If this equipment does cause harmful interference to radio or television reception, which can be determined by turning the equipment off and on, the user is encouraged to try to correct the interference by one or more of the following measures:

- Reorient or relocate the receiving antenna.
- Increase the separation between the equipment and receiver.
- Connect the equipment into an outlet on a circuit different from that to which the receiver is connected.
- Consult the dealer or an experienced radio/TV technician for help.

## PANEL DESCRIPTIONS

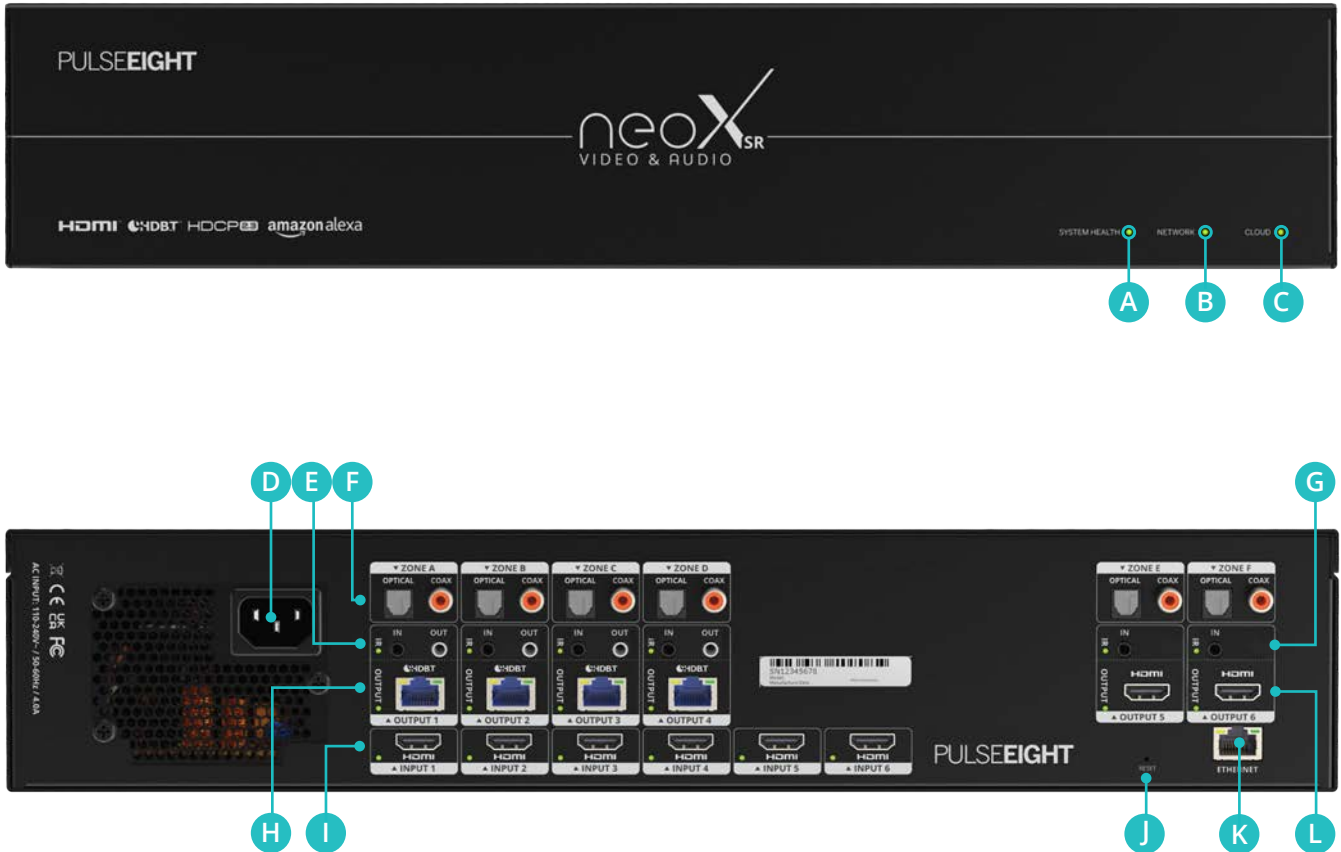

- A System Health LED** indicates matrix health.

  - RED - It is powering on or fault found.
  - GREEN - The system is healthy.
  
- B Network LED** indicates the matrix network connection.

  - RED - No network cable is connected.
  - AMBER (Flashing) - It discovers the IP address.
  - AMBER (Solid) - The network has the IP but cannot ping the router.
  - GREEN (Flashing) - The network cannot reach the internet.
  - GREEN (Solid) - The network is healthy.
  
- C Cloud LED** indicates the matrix connection to the Pulse-Eight Cloud.

  - RED - It is not connected to the cloud.
  - GREEN - It is connected to the cloud.

- D Power Connector** is used with the supplied power cord to connect the power.
- E IR IN and OUT Ports** connect as required.  
The IR IN port (black) can be used to accept and distribute IR signals from a controller using a P8-IR-Optocable, as well as distribute IR signals back to the matrix using a compliant Pulse-Eight IR Receiver.  
The IR OUT port (grey) is used to control the connected HDMI® Source device (STB, Blu-Ray, etc) using a compliant Pulse-Eight IR Emitter.
- F Audio Outputs:** Optical and Digital Coax options for Audio Breakouts.
- G HDMI® IR IN** connect as required.  
The Input IR port (black) can be connected to receive and distribute IR signals from a connected HDMI® extender.
- H HDBaseT Outputs:** Connect the appropriate Cat 5e or higher grade cable to each output. These cables should then be connected to a neo Receiver at each Sink device. (TV/Amplifier etc.).
- I HDMI® Inputs:** Connect the appropriate high speed HDMI® cable to each input. These cables should then be connected to the Source device. (Blu-Ray player etc.)
- J Reset:** Factory reset - Please use only when instructed by our customer service team.
- K Ethernet:** Connect to network - Required for connection to Web Interface, Third Party Control, and Cloud Remote Monitoring Portal.
- L HDMI® Outputs:** Connect the appropriate high speed HDMI® cable to each output. These cables should then be directly connected to each Sink device. (TV/Amplifier etc.)

## INFRARED BLASTER CABLE PACK

1. **IR Transmitter 3.5mm Stereo Jack** - An IR flasher (emitter) is required when wanting to output (blast) an IR command to an attached device. Please use compliant Pulse-Eight IR emitters (5V) as failure to do so might result in damage to the product.



2. **IR Receiver 3.5mm Stereo Jack** - An IR receiver is required when wanting to accept incoming IR signals - for example, from a remote control - to distribute and control other attached devices remotely. Please use compliant Pulse-Eight IR receivers (5V) as failure to do so might result in damage to the product.



## NEO:ULTRASR RECEIVER

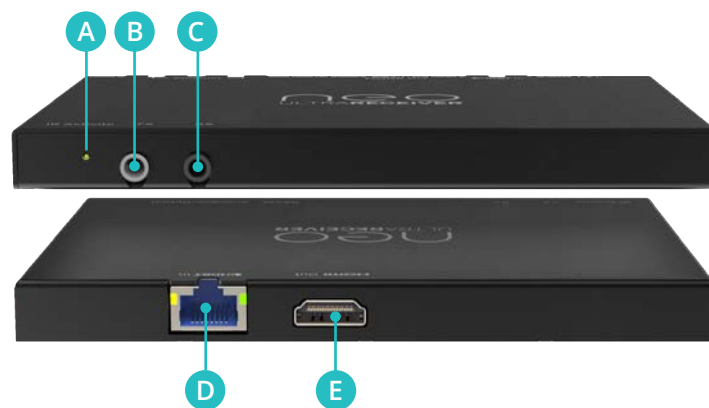

- A IR Activity Indicator** - The LED will flash green when an IR signal is being received and red when an IR signal is being transmitted.
- B IR Flasher (TX)** - The IR Flasher port (grey) is used to control the connected HDMI® Sink device (TV) using the IR transmitter.
- C IR Receiver (RX)** - The IR Receiver port (black) can be used to distribute IR signals back to the matrix when connecting an IR Receiver.
- D HDBaseT Input** - Connect the appropriate category cable (Cat 6 or higher recommended) to the each input of the receiver; these cables should then be connected to one of the HDBaseT outputs on the matrix. The LEDs will illuminate to indicate a link (amber LED) and video (green LED) is being received.
- E HDMI® Output** - Connect the appropriate high speed HDMI® cable to this port and connect to the sink device.



## HDBASET CABLING

### What Is The Best Type Of Cable To Use?

Pulse-Eight products use the HDBaseT standard, which makes use of standard Category (Cat) cables. The minimum cable used on a neo system is Cat 5e, but it is recommended to use a higher tier cable such as Cat 6, Cat 6A, or Cat 7 where possible because they have stricter twisted pair and shielding requirements that reduce data loss between data pairs.

Patch cabling is strongly discouraged because it can degrade the signal. Use a long, single high-quality cable for each HDBaseT port whenever possible to allow the system to function at its best.

We do not recommend using pre-made leads unless you are certain of the correct specifications (i.e., solid core 568B); using lower quality cables will result in signal degradation and transmission quality.

**Note:** Please keep in mind that Copper Clad Aluminum (CCA) cables aren't supported. This will cause a HDBaseT performance issue due to the inherent properties of a CCA.

### Shielded Cables

If you prefer shielded FTP cables, please use compatible shielded features such as grounding and termination. A faulty cable can increase interference rather than eliminate it.

### Cabling Best Practice

Our recommended and best practise policy is to connect the Pulse-Eight matrix directly to the receiver using a straight cable. This will ensure the best signal quality and the greatest possible distance. On the HDBaseT Alliance website, you can find more information on "HDBaseT Best Practices."

<https://installers.hdbaset.org/wp-content/uploads/2014/09/Dos-and-Donts-WP.pdf>

### Wall Plates and Patch Panels

If the patch panels are properly terminated, there should be little distance loss. However, the use of wall plates and patch panels has the potential to increase cable resistance and, if not done correctly, could reduce advertised transmission lengths. Brush plates can be used instead of RJ45 wall plates to keep the finish neat.

### Connection Termination

For Cat 5/Cat 6 UTP (unshielded) cable, we recommend using full plastic encasements rather than metal ones to avoid any grounding leaks into the Pulse-Eight products. However, when using shielded cables (STP), then please ensure to use metal connectors and that the Cat cable's shield/foil and drain wire are making good contact with the connector's shell.

Terminate the cabling using RJ45 connectors to the 568B wiring standard. (See diagram below).

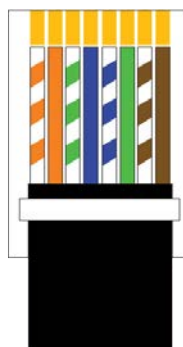

**IMPORTANT:** Please note that local building regulations may apply to the installation of cabling in properties. It is important to check building regulations to guarantee that you are in accordance with the laws of your territory.

## IR PIN ASSIGNMENTS

Pulse-Eight strongly recommends the use of the IR accessories provided. We do not support 3rd party IR component as it could damage the matrix.

The standard range of Pulse-Eight matrices utilise a 3.5mm stereo jack, both for IR flashers and receivers buds. We strongly recommend purchasing a Pulse-Eight Mono-Stereo Optocable when necessary in your installation.

 *Note: If you do require rewiring the IR plug to work with a 3rd party device then please note that this will void the warranty on the matrix if there is damage caused.  
The Schematic provided below is as a reference only.*

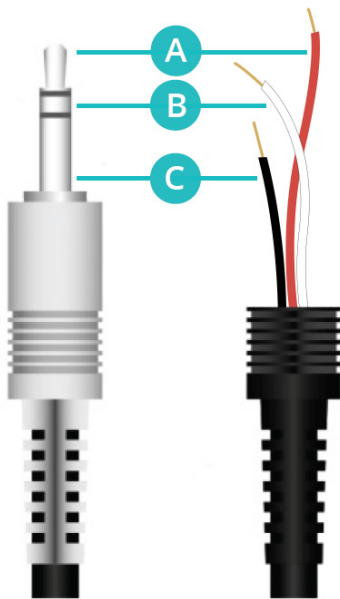

- A** Tip - 5V Power (receiver only).
- B** Ring - IR Signal.
- C** Sleeve - Ground

## INSTALLATION

### Installing In A Rack

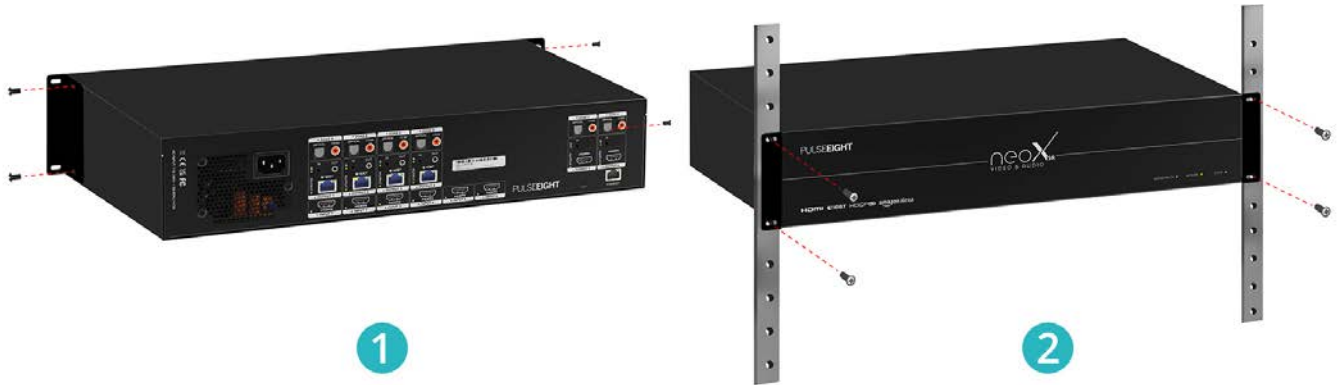

1. Attach the rack ears to the front sides of the matrix using the provided screws.
2. Install into the rack and connect cabling according to the mode of operation – as described below.

**⚠ WARNING:** To prevent damage, it is important to ensure adequate ventilation space on the sides of the matrix, especially on the ventilation openings on the side of the product enclosure.

### Connecting The Inputs



**LEGEND**

- ⋯ Infrared
- HDBaseT
- Digital Audio
- Analogue Audio
- Ethernet
- Speaker
- HDMI

1. Connect HDMI® cables from your video sources (e.g. Blu-Ray player) to the HDMI® inputs of the matrix.
2. If required, connect the compatible IR Flasher (Emitter/Transmitter) cable to the 'OUT' port (grey) on the matrix and the IR bud placed over the source device's IR window.

**ⓘ Note:** It is recommended, for ease of setup, to connect devices from Input 1 to Input 6 first. IR OUT (flasher) is only available for Inputs 1, 2, 3 and 4. There are no IR flashing capabilities for Inputs 5 and 6.

## Connecting The HDBaseT Outputs

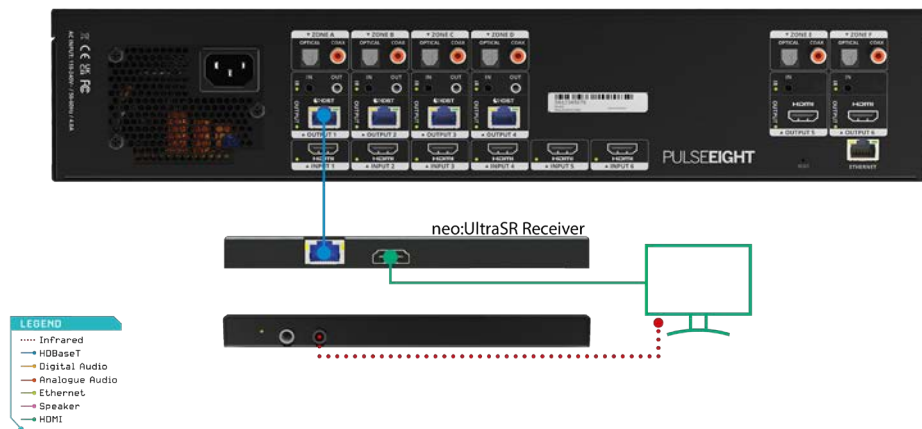

1. Connect the appropriate category cable (Cat 6 or higher recommended) to each HDBaseT output ports that you require.
  - Note:** It is recommended, for ease of setup, to connect devices from Output 1 to Output 4 first.
2. Complete the connection by attaching the other end of the Cat cable to a supplied neo Receiver's 'HDBaseT In' port. The neo Receiver should be situated at the output end (i.e. next to the TV).
  - Note:** Use only neo:Ultra Receiver (P8-HDBT2-U-RX) or neo:UltraSR Receiver (P8-HDBT2-L-RX)
3. Connect HDMI® Out on the neo Receiver to the sink device (i.e. TV) using a high-speed HDMI® cable.
4. If required, connect the IR Receiver to the neo Receiver's 'IR Receiver' port - and place the IR bud on the underside of the sink device (i.e. TV).

**⚠ WARNING:** Please make sure to use a compatible 5V IR receiver/transmitter on this product. Please refer to IR Receiver and IR Flasher in the Compatible Devices section.

## Connecting The HDMI® Outputs



For Output ports 5 and 6, connect sink devices (e.g. TVs) directly via high speed HDMI® cables.

- Note:** Can also be used in conjunction with a Pulse-Eight neo HDMI® Extender Set (sold separately) for reaching further distances.

## Connecting The Audio Outputs



If you wish to use the audio outputs from the matrix, please connect cables to the relevant output. There are 6 output zones, where each zone features Optical and Digital Coax options that can work simultaneously.

There are two audio modes of operation: **Source Mode** and **Sink Mode**.

By default, when you first install the matrix, the unit is set to sink mode with each zone set to passive.

 *Note: The audio outputs allow matrixing in Sink Mode, please refer to Web Interface Setup to find out more.*

 **IMPORTANT:** The matrix needs to be set to Sink mode or Source mode according to the installation's requirement, and wired accordingly. Please ensure that you set up the matrix to the correct audio mode in the Audio Control tab of the WebUI.

### SINK MODE VS SOURCE MODE

**Sink Mode** is the preferred method when setting up the neo:XSR in an installation that does not have a dedicated audio matrix switch.

Sink mode allows for audio routing from any input to any of the audio output zones, which by default is intended to match the video routing.

There are two sub-modes of operation for each output zone:

- ARC (HDMI®). When feature is enabled, the matrix will automatically manage when audio is coming directly from the TV, over the HDMI® Audio Return Channel (ARC), and output over the respective audio zone output.
- Disabled. This feature will disabled the ARC feature.

**Source Mode** is generally used in larger installations where the input audio is being fed directly to one or more dedicated audio matrices (e.g. ProAudio switch).

In this mode, the audio outputs zones A to F are locked to HDMI® inputs 1 to 6 respectively.

## Connecting To The Network



It is necessary to connect a standard Ethernet cable (Category 5e/6/7) from the matrix's 'Ethernet' port to your router or network switch. Crossover cables are not supported.

**Note:** A network connection is required for supporting full control/remote monitoring features of the product.

## Turning On The Matrix



1. Insert the supplied power cord and plug into the AC mains and turn it on.
2. As it powers ON, the front panel LEDs (System Health, Network, Cloud) will illuminate momentarily before it begins its initialization sequence.

**Note:** The initialization process takes between 20 seconds and up to 2 minutes. However, it is possible that a firmware update may be available the first time the unit is powered ON - in this instance the matrix may take longer to initialize. If both the System Health and Network LEDs flash (green) quickly together then a firmware update is being applied. Please wait and do not disconnect the power until this update has completed.

3. Once initialization has been completed, the System Health, Network and Cloud LEDs should all appear ON (green).
4. Check the LED status on the attached neo Receivers to ensure correct installation and connection. See LED Status in Troubleshooting section.

**Note:** When a link is established between the Matrix and the Neo Receiver, the orange LED on the HDBaseT port on the Neo Receiver will illuminate (at this point you can assume that the neo receiver is powered on).

## IR RECEIVER AND TRANSMITTER PORTS



**This section is only required when utilizing IR flashers or Receivers in your installation.**

1. The IR ports above the HDBaseT outputs work as follows:

- IN port (black) is a 3.5mm stereo socket that accepts an IR input signal coming into the matrix intended to be sent to another room over the HDBT output below. It extends the IR signal from the matrix to the attached neo Receiver's IR-Flasher port.  
You can connect these ports directly to a 3rd party Control system processor/controller. A P8-IR-Optocable might be required.
- OUT port (grey) is a 3.5mm stereo socket output designed to attach an IR Flasher to control the Source (Blu-ray, STB, etc) connected to the HDMI® input below. The original IR signal can come from the following:
  - "IP to IR Blasting" feature, exclusive to Control4, allows for an IP command to be converted to IR signal intended for the attached source. See more information on the "IR Blasting" section.
  - Any IR signal received by an attached neo Receiver will be routed back to the corresponding 'IR OUT' port, according to the video routing to that HDBT output – e.g. if the matrix is routing video from HDMI® In #2 on to HDBT out # 4, then the any IR signal received by the neo Receiver attached to HDBT port #4 will be routed and blasted out the matrix's IR OUT port #2.

 *Note: There are no IR ports (IN or OUT) above the HDMI inputs 5 and 6.*

2. The IR ports above the HDMI® outputs are a little different:

- IN port is only required when using an external HDBaseT extender. It is designed to receive the incoming IR signal from the HDBaseT set connected to the HDMI® output. The IR signal will then be routed to the corresponding 'IR OUT' port on the matrix according to the video routing.

 *Note: If a display is connected locally (i.e. there is no HDBaseT extender set connected to HDMI® output) then this IR INPUT port should generally not be required in an installation.*



## WIRING GUIDELINES

### Source Mode

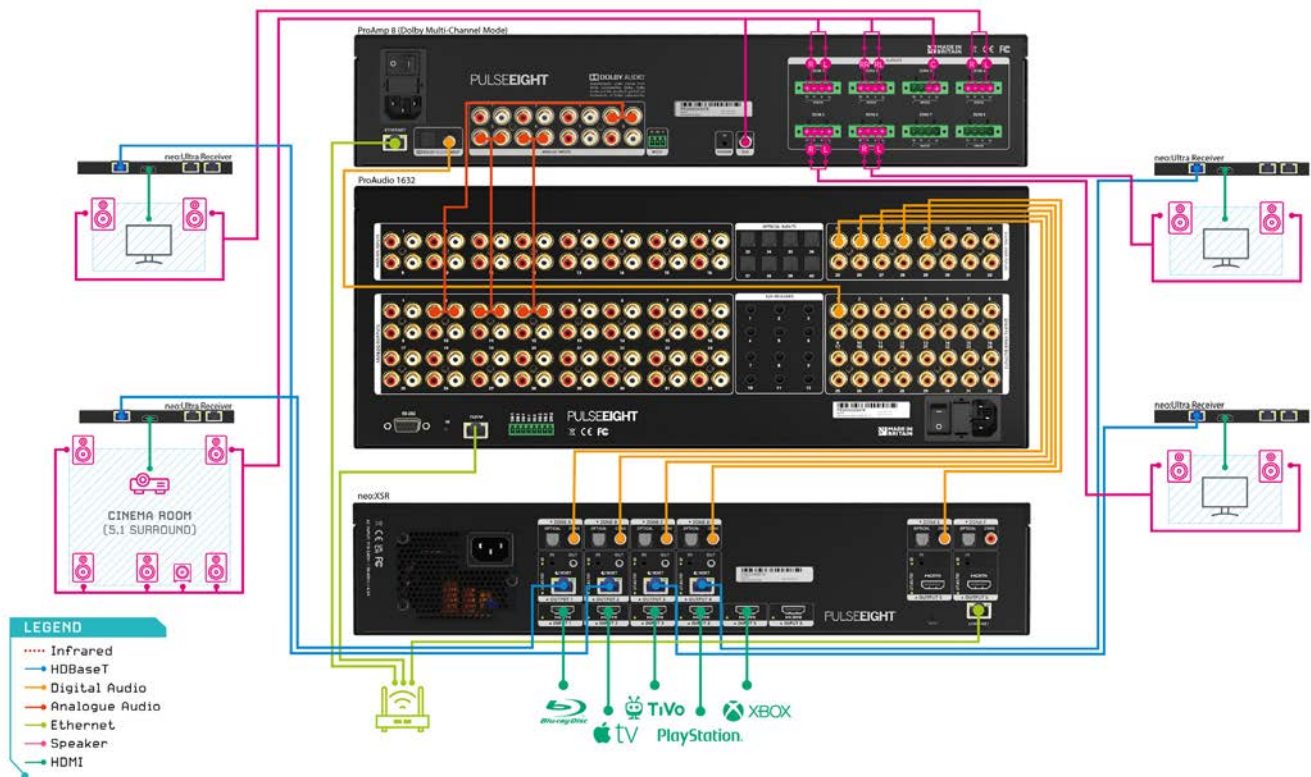

This is an example of a wiring diagram of the neo:XSR with a dedicated audio matrix switch (e.g. ProAudio1632) and an amplifier (e.g. ProAmp8).

### Sink Mode

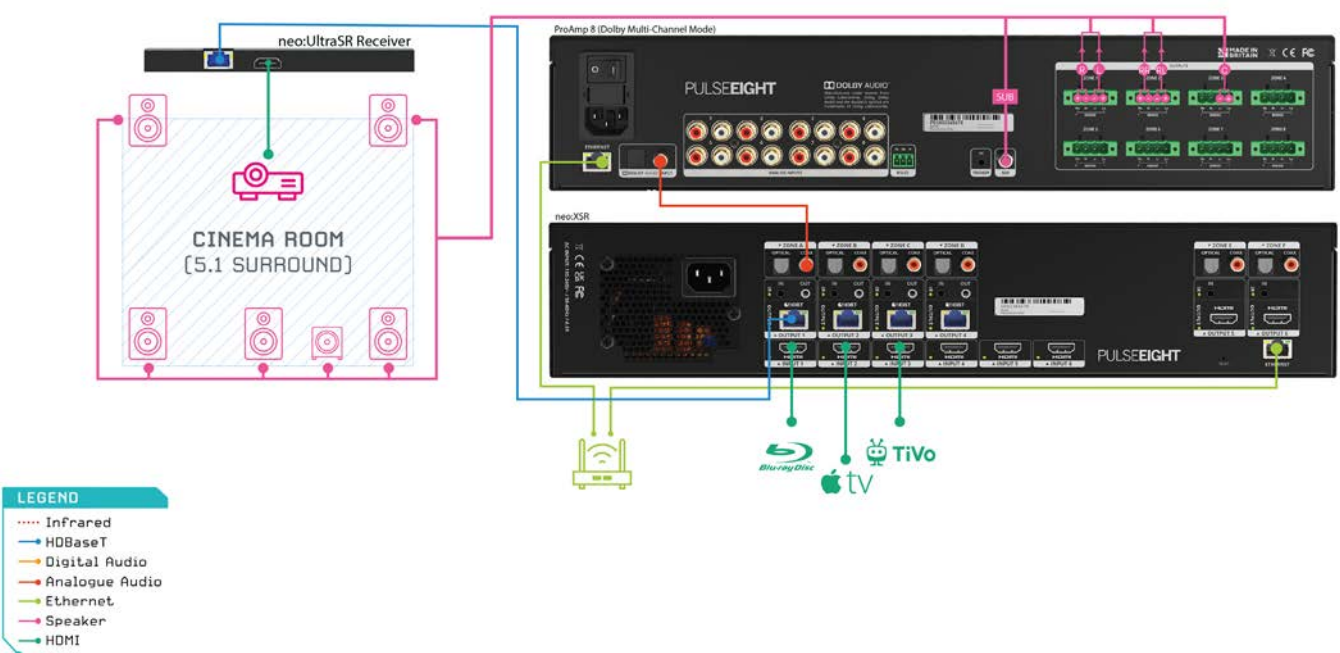

This is an example of a wiring diagram of the neo:XSR without an external Audio Matrix Switch.



## NEO WEB INTERFACE

The front page of the web interface features a user-friendly drag and drop for video routing and display showing all available inputs and outputs. The following steps instruct how to access and customise this for the end-user.

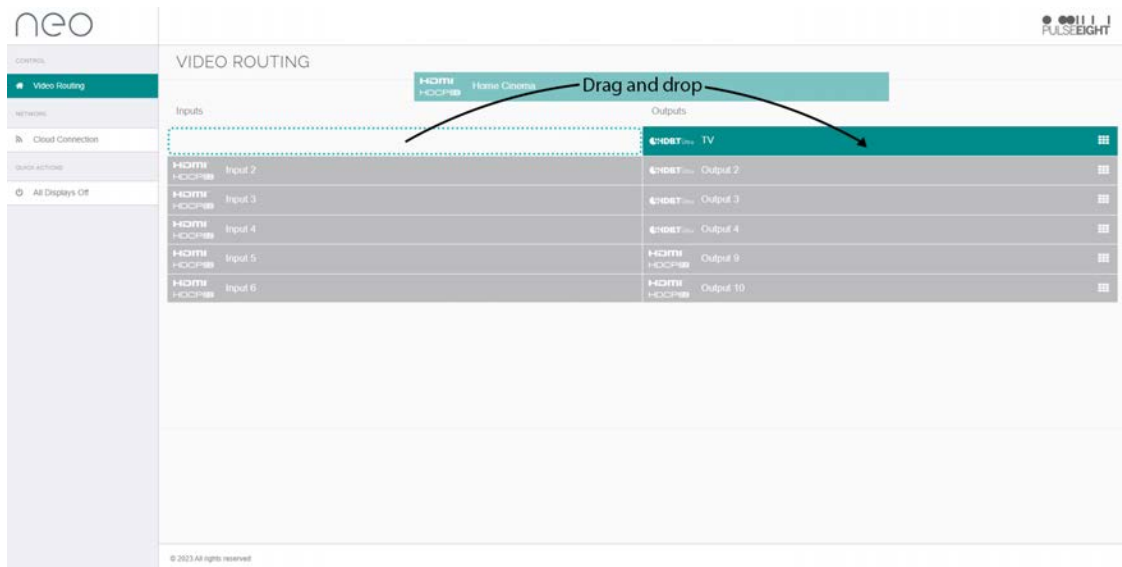

### Accessing The Admin Area

When setting up the neo:XSR matrix, it is important that the installer can access the admin menu on the Web Interface to configure the matrix according to the installation's requirements.

The Web Interface can be accessed using a computer connected to the same router/network as the matrix and by visiting [www.gotomymatrix.com](http://www.gotomymatrix.com) in your web browser. Navigate to the Cloud Connection tab (on the left-hand side) and then click on '[Admin]' link at the foot of the page. Insert your password to log in and access all options.

**Note:** The default password is **"admin"**. It is recommended that this is changed to a unique and memorable password once setup has been completed.

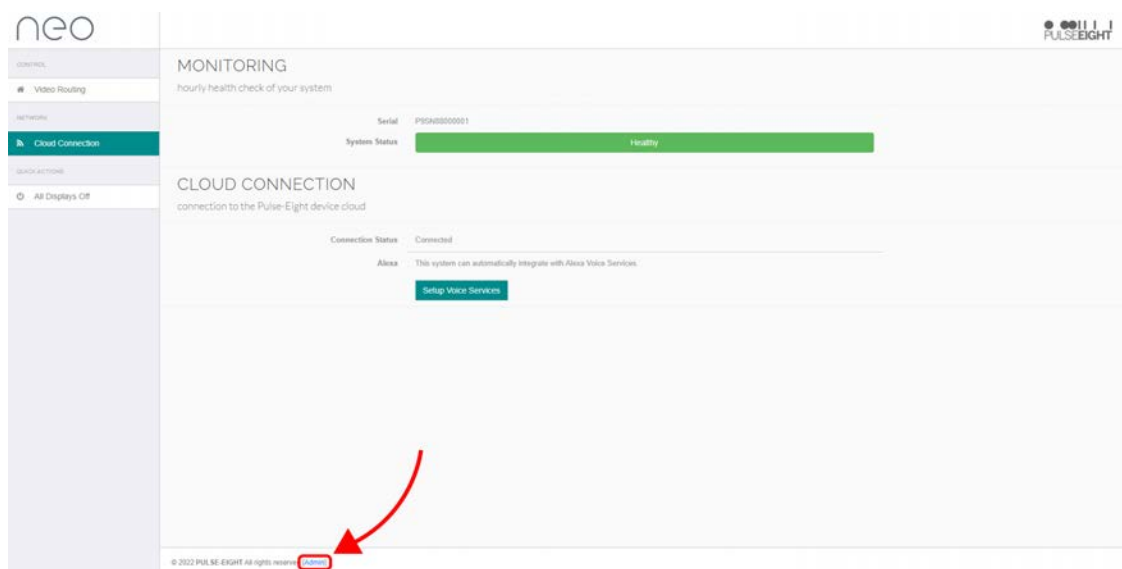

## Link The Installer Account

On the Cloud Connection page, insert your Pulse-Eight Installer ID (4-digit) into the box and save changes - this will enable the matrix to be linked to your monitoring account.



**Note:** If you do not already have an Installer ID then you will need to register for a new account. Please contact your local representative or visit [monitoring.pulse-eight.com/Account/Register](https://monitoring.pulse-eight.com/Account/Register).

Once you have entered your Installer ID, you will be able to gain access to the Cloud Monitoring Service to monitor all of your Pulse-Eight installations remotely in one place.

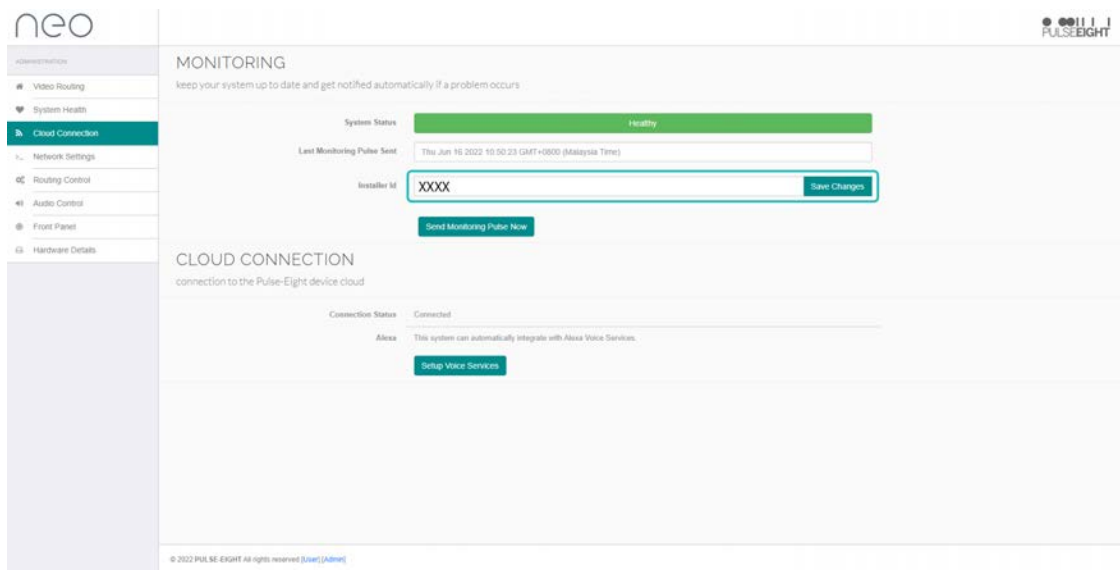
For more information, refer to the “Accessing the Monitoring Portal” section in this manual.



## Input and Output Options Setup

To access the Input and Output Setup options, click on the  symbol for changing the selected Input settings and the  symbol for changing the selected output settings.

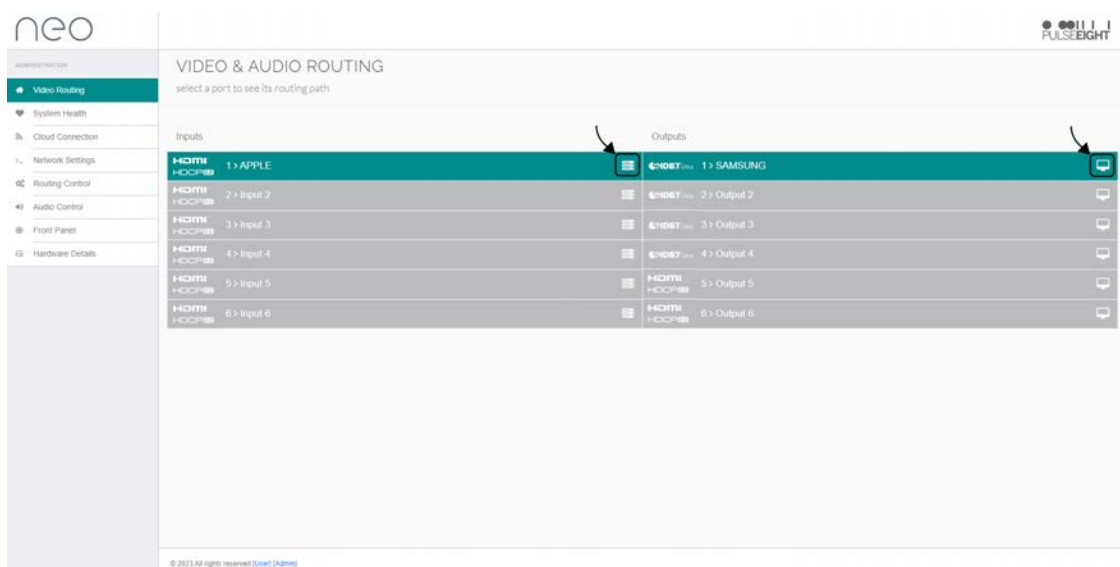

## Input Setup Options

Input 1
✕

---

**Name**

**Control Method**

**Mode:** Detecting

**Hidden**

**EDID Profile**

**Video Signal** 2160p50 HDMI

**Name:** Change the name of the selected input. This name will be displayed on the source list on the display device (TV) menu.

**Control Method:** Change the control method for the supported Set Top Box. They are:

- CEC (default control)
- Sky UK
- TiVo/Virgin
- Kodi
- Dish
- DirecTV

If using IR blasting to control attached sources, then leave the control method as CEC (default)

*Note: The listed Set Top Boxes (i.e Sky/Virgin/TiVo/Kodi/Dish/DirectTV) can be controlled automatically by the matrix over IP. You will need to enter the IP address of the STB.*

*The matrix will need to reboot for the changes to take effect and for the control to work.*

**Hidden:** Turn on to hide the selected input from the end user's web interface.

**EDID Profile:** Drop down menu to select an alternative EDID profile for the selected Input. See the EDID Management section of this manual for more information.

**EDID Details:** This will bring up a page detailing the current EDID information for the selected Input.

## Output Setup Options

Output 1
✕

**Name**

**Video From**

**Mirror**

**EDID** EDID Details

**Hidden**  Source Filtering

**Link Status** HDBaseT (Active) Remote Module Details

**Link Quality** Good (1080p)      **Cable Length** < 20m

Unlink
Close
Save changes

**Name:** Change the name of the selected output.

**Video From:** A dropdown list displaying the current source of the output and allowing you to change the routing for this output.

**Mirror:** Select an output from the list for the video to mirror another display (selected output).

**EDID Details:** This will bring up a page detailing the EDID information of the HDMI® Sink (display) connected to that output.

**Hidden:** The toggle switch can be turned on to hide the selected output from the end user's web interface.

**Source Filtering:** Toggle switches to select which inputs can be routed to the selected output display.

**Link Status:** Indicates if the HDBT link is active.

**Remote Module Details:** This will display a popup providing details on the attached neo Receiver.

**Link Quality:** Indicated the quality of the link. Click the icon to view Link Quality Test Tool.

**Cable Length:** Indicates the approximate length of the Cat cable inserted into the output. This is an estimate based on the cable's performance and may not be accurate.

**Linked Device:** This allows you to link this device with other Pulse-Eight products (e.g. ProAudio and/or ProAmp8) in the same network and installation.

**Audio Only Mode (HDMI® outputs only):** When either of the HDMI® Outputs is set to mirror another video output port and saved, a new Option/Mode for that output port's settings will appear. The Audio Only Mode switch allows the matrix to use CEC commands to control the attached AVR volume. This works by the TV sending Volume control messages back to the matrix which are then passed to this mirrored port.

*Note: Ensure that after any changes you click the 'Save Changes' button.*

## System Health

**SYSTEM HEALTH**  
how your hardware is performing

System Status	Healthy
Power Supply	Present & Healthy
Inputs	All Present & Healthy
Outputs	All Present & Healthy
Network Connectivity	Healthy
Temperature Sensor 1	42° degrees
Temperature Sensor 2	38° degrees
Temperature Sensor 3	40° degrees
Temperature Sensor 4	54° degrees
Temperature Sensor 5	44° degrees

**ADVANCED DIAGNOSTICS**  
perform detailed tests on specific areas of your installation to identify potential faults

- IR Noise** - This test will check to see if any IR data is being received over a sustained period of time, failing this test would indicate that the IR receiver is picking up noise. This could be from a Plasma TV or a faulty light fitting. [Start Test](#)
- HDBaseT™ Link Quality** - This test will check to see the HDBaseT link is stable over a sustained period of time. [Start Test](#)

Under the System Health tab, information about the hardware's performance is displayed. The colour-coded boxes (Green = Good, Orange = Warning, Red = Issue) will indicate if it is performing correctly along with the reading of the internal temperature sensor that will indicate if the system is overheating.

Under the System Details Health tab, you will also find Advanced Diagnostics that will perform detailed tests on specific areas of your installation to identify potential faults.

## IR Noise Test

**IR Noise Test**

Test Time Remaining: 00:02:51

Output 1	Green
Output 2	Green
Output 3	Green
Output 4	Green
Output 5	Green
Output 6	Green
Output 7	Green
Output 8	Green
Output 9	Green
Output 10	Green

[Cancel](#)

The IR Noise Test will check to see if any unwanted IR noise is being received over a sustained period of time for each port. Failing this test would indicate that the IR receiver on its video output zone (neo receiver) is picking up noise in its environment.

*Example of failure message:*

*The IR receiver connected to this port is occasionally picking up stray IR messages, this may occasionally interrupt IR communication to the connected source device and/or control system. If you repeat this test and it remains in this state, we recommend relocating the IR emitter.*

## HDBaseT Link Quality Test

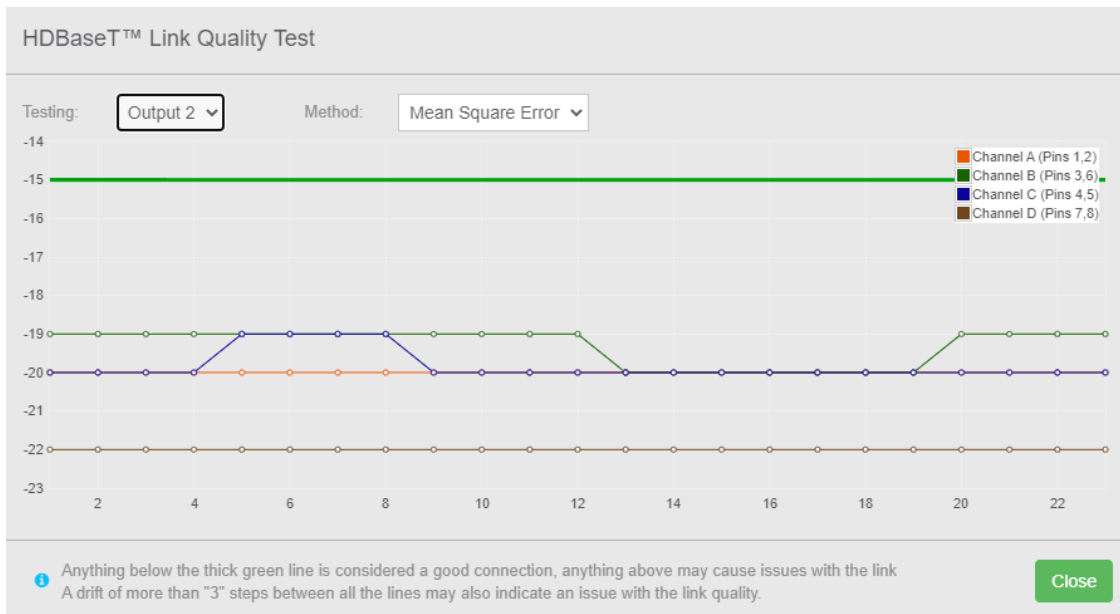

The HDBaseT Link Quality Test will check the HDBaseT link is stable over a sustained period of time. There are two drop down menus, the first is the output you are testing, the second is the type of test you are doing.

The **Mean Square Error** test is the ratio (in dB) of the signal power in relation to the originally transmitted signal vs the received and it is an analog measurement. This reading is directly affected by kinks, termination & other cable issues. Each Channel has a colour that represents the same colour in the twisted pair in the Cat cable. All four of these Channels should each be below the -15dB line. Otherwise, the cable quality will be marked as “Poor”. Also, all four of these Channels should be within 3dB’s of each other, for example, -21dB. -20dB. -21dB & -19dB. Otherwise, the cable quality will be marked as “Poor”.

**Note:** *If any of the above criteria is broken at any time but it then recovers to normal, this can still indicate an issue in the cabling so the matrix will remember this information and will continue to mark the cable as “Poor”. This can explain if your cables look to meet the MSE test criteria but are still marked as “Poor” then it is likely to be caused by a momentary “bad spike” (reading below MSE criteria) happening in the past.*

The **Channel Errors** test is a measurement of the number of digital errors on the channel, such as packet loss and bit errors. Each Channel has a colour that represents the same colour as the twisted pair in the Cat cable. All four of these Channels should be below the 40-line. Otherwise, the cable quality will be marked as “Poor”. Also, all four of these Channels should be within 3 of each other, for example, 35. 36. 35. 34. Otherwise, the cable quality will be marked as “Poor”.

**Note:** *If any of the above criteria is broken at any time for any of the channels but it then recovers to normal, this can still indicate an issue in the cabling so the matrix will remember this information and will continue to mark the cable as “Poor”. This can explain if your cables look to meet the Channel Error test criteria but are still marked as “Poor” then it is likely to be caused by a momentary “bad reading” (below Channel Error criteria) happening in the past.*

It is also possible to check the link quality remotely by logging into your installer account at [monitoring.pulse-eight.com](http://monitoring.pulse-eight.com)

## Cloud Connection

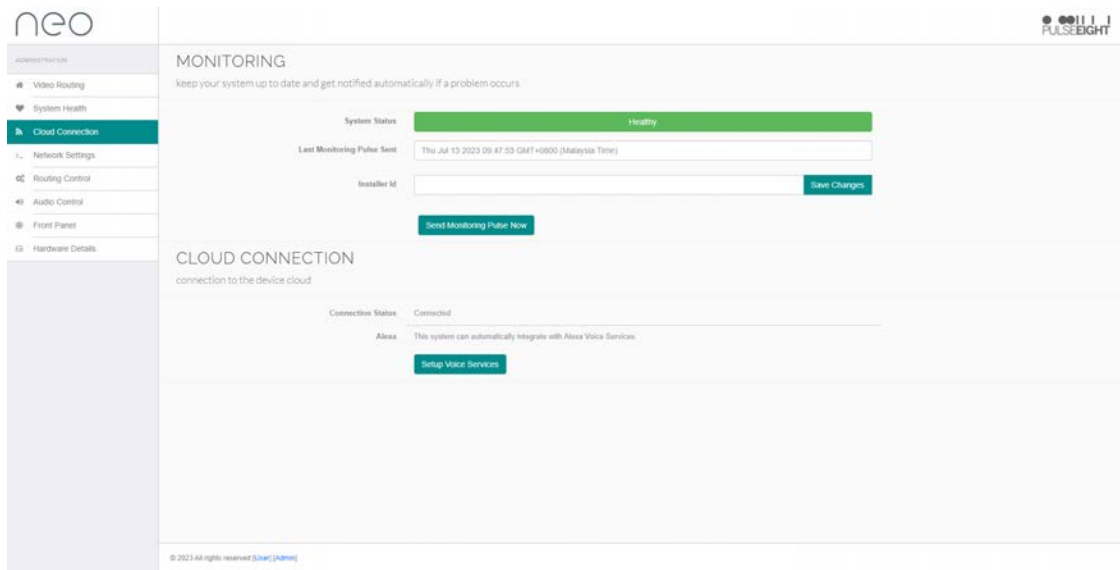

Under the Cloud Connection tab, you will have basic monitoring information:

**System Status:** This colour-coded status (Green = Good, Orange = Warning, Red = Issue) will notify you if the system is healthy or if there is an issue.

**Last Monitoring Pulse Sent:** This will indicate the date and time when the matrix last 'phoned home'.

**Installer ID:** Enter your Pulse-Eight Installer ID to link to the Pulse-Eight Monitoring Portal.

**Connection Status:** This will detail if the matrix is connected to the Pulse-Eight Monitoring Portal.

**Alexa:** This matrix can be controlled by Alexa's voice command control. To set this up, please follow the 'Alexa Voice Control' section for further details.

### ALEXA VOICE CONTROL

It is possible to add the neo:XSR matrix to your Alexa smart-home setup in order to control the attached Sink and Sources using voice commands.

1. Install the 'neo' Alexa skill from Amazon on the Alexa app.
2. On the Cloud Connection tab, click the 'Setup Voice Services' button, this will take you to - my.pulse-eight.com with instructions on setup.
3. Click on the 'Login via Amazon' button and proceed to login to your Amazon account. A page will appear listing your discovered devices - these are the systems available for Alexa control. Click 'Connect' next to the appropriate system.
4. Tell Alexa to 'Discover Devices' - your system should now be connected.

*Note: Alexa is a virtual assistant AI technology developed by Amazon. It is capable of voice interaction with smart speakers, but it is also used to control smart devices in home automation systems.*

**IMPORTANT:** It should be noted that your Input and Output names on our webpage should begin differently. For example, if you have two inputs named Sky 1 and Sky 2, this can cause issues with Alexa. These should be renamed to something different, such as Mini Sky & Sky. The same applies to output names.

## Network Settings

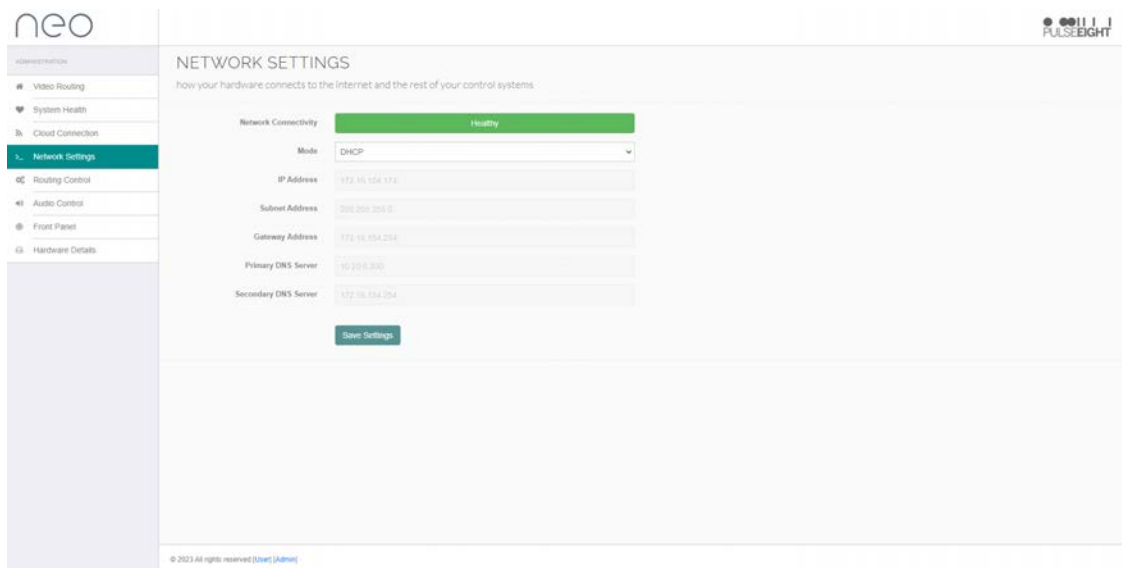

Under the Network Settings tab you will find details about the system's connection to the internet and the rest of your control systems:

**Network Connectivity:** This colour-coded status (Green = Good, Orange = Warning, Red = Issue) will notify you if the system is connected to a network or if there is an issue.

**Mode:** Dropdown menu to either set a static IP and DHCP.

 **IMPORTANT:** Ensure that after making any changes to network settings, that you click Save Settings button.

### ACCESSING THE MATRIX WITHOUT AN INTERNET CONNECTION

While the neo video matrix works best with an active internet connection it is possible to still configure and operate the system without one. However, to configure the system from its defaults a local network connection is required. Normal operation of the CEC and IR control systems does not require any network connection, but IP-based API control or Web-based control does require a persistent network connection.

#### Discovery Tool

You can download a discovery tool from your monitoring portal at <http://monitoring.pulse-eight.com/> this program will run on Windows 7 or newer only. When run it will scan your network and detect the IP address of your matrix. If you have multiple neo devices on the same network, the discovery tool will only display the last found. If you do have more than one system, it is advised that you disconnect other systems first.

The discovery tool will display the IP address of the matrix, you can then access the matrix by typing that IP address into your web browser's address bar.

 *Note: It is recommended in this mode that you configure the networking to use a static IP address, this allows you to bookmark the page easily and return to the web interface easily without needing to run the discovery tool again.*



## Routing Control Tab

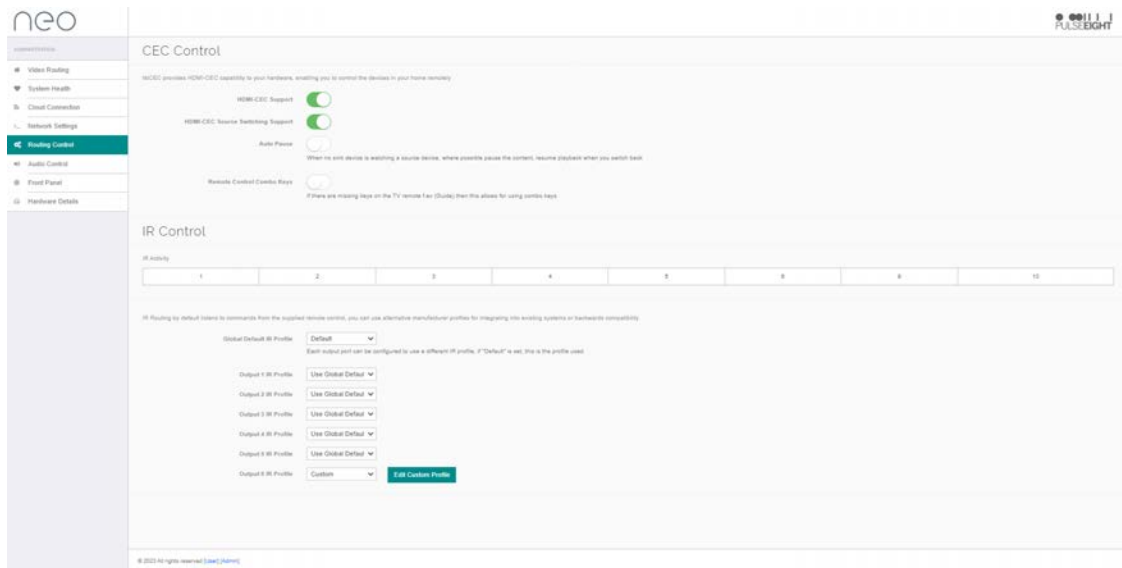

Under the Routing Control tab, you will find settings for CEC control and IR Control Section:

### CEC Control

**HDMI-CEC Support:** Toggle switch to turn CEC control on or off, according to your requirements. By having CEC turned on, you will have the ability to control your connected devices (with CEC) without the need for a third-party Control system. The matrix can work independently. If no CEC features are used in the installation, then we recommend turning this off. However, please note that this will also disable HDMI® ARC as it utilises CEC.

**HDMI® CEC Source Switching Support:** This allows you to turn off/on the CEC source switching feature while keeping all other CEC features working, assuming that HDMI-CEC Support is still enabled.

**Auto Pause:** This feature utilises CEC and allows the matrix to automatically pause content from a Source (e.g. movie) when turning the TV off and then continue playing when routing the connected Source to another room. When the feature is not used, it is recommended to turn it off.

**Remote Control Combo Keys:** Toggle switch to turn on this function. If there are missing/broken keys on the TV's remote – e.g. the Guide button - then enabling this function allows you to use a combination of keys on the remote instead to achieve the missing function.

### IR Control

**IR Activity:** A useful test for IR activity. The panel lists each IR activity box which will illuminate whenever an IR signal is received over the video output ports (HDBaseT or HDMI®).

**IR Control Settings:** IR Routing by default listens to commands from the supplied remote control to control the attached sources (e.g. play, pause, etc). However, you can also use alternative manufacturer profiles (e.g. Bang & Olufsen) for easily integrating into existing systems and backward compatibility.

Each output port can be configured to use a different IR profile, if "Default" is set, this is the profile used.

## Audio Control

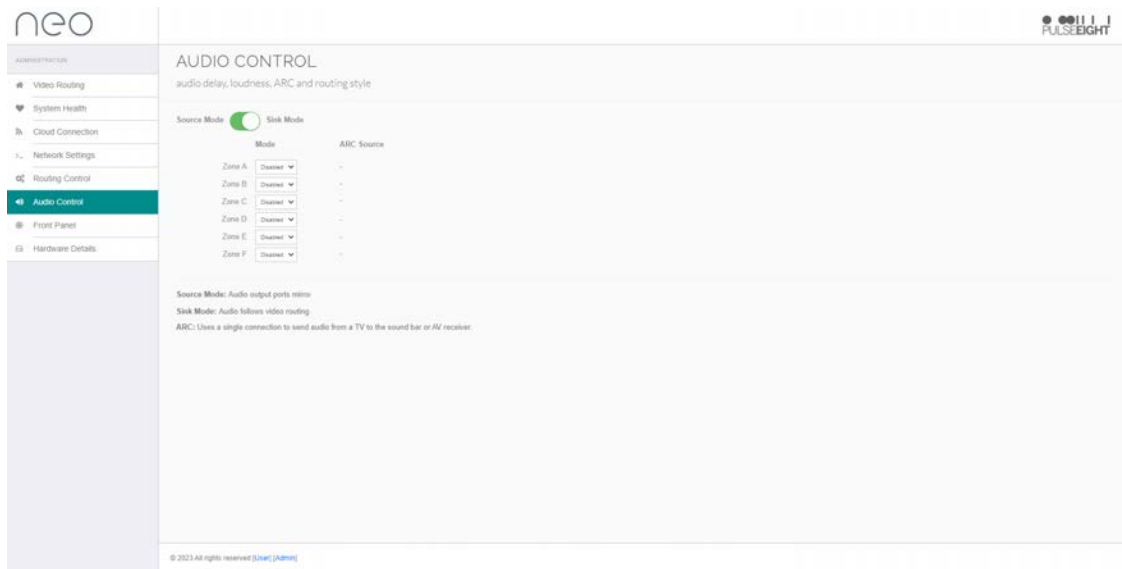

The Audio Control tab features audio routing settings for each audio output zone of the matrix.

**Source Mode / Sink Mode** switch. Toggle switch according to your installation requirements. See “Connecting The Audio Outputs” in the Setup section of this manual.

ARC: A dropdown menu to select audio return function - choose between HDMI®, or Disabled depending on the connection you have chosen on the Receiver.

ARC Source: Displays the audio return source when HDMI-ARC is selected.

## Front Panel Settings

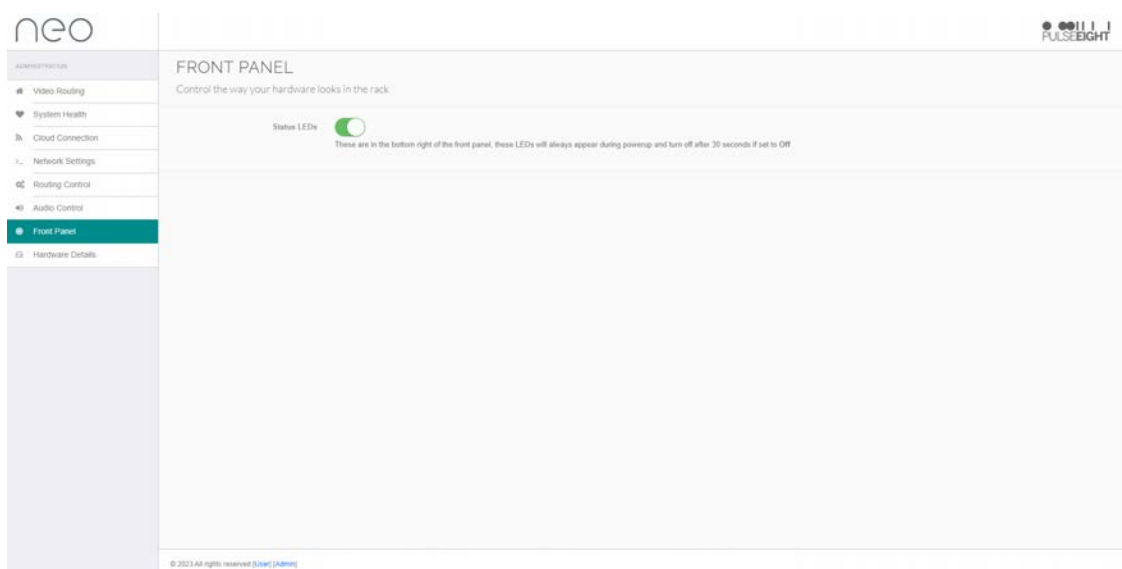

Under the Front Panel tab, you will find options for the front panel of the matrix for turning off the status LEDs.

**Note:** The status LEDs are in the bottom right of the front panel, these LEDs will always appear during powerup and turn off after 30 seconds if set to Off.

## Hardware Details

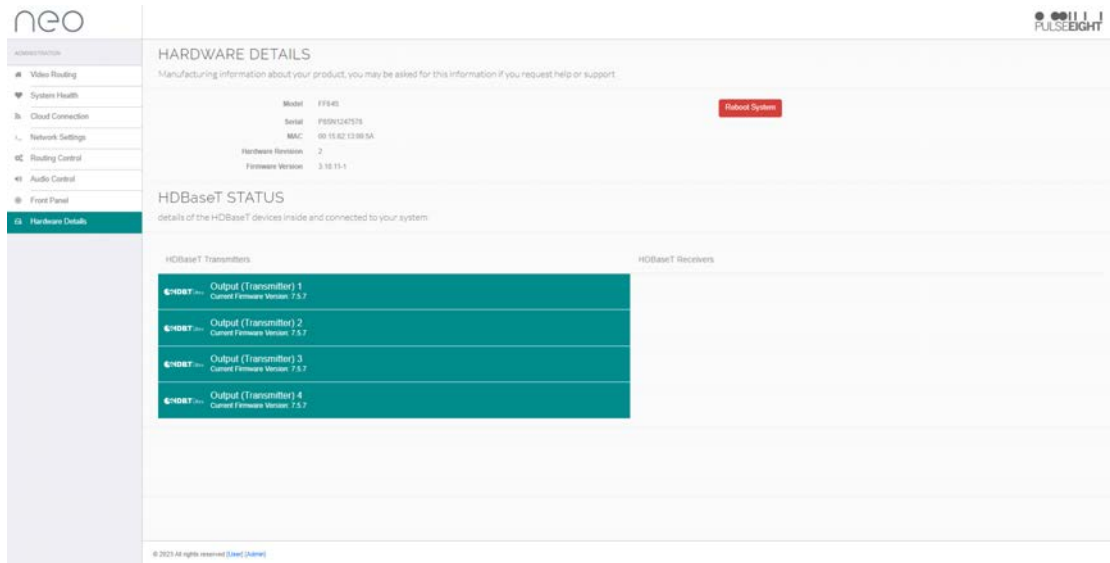

The screenshot shows the 'Hardware Details' page in the Pulse Eight web interface. The page is divided into two main sections: 'HARDWARE DETAILS' and 'HDBaseT STATUS'.

**HARDWARE DETAILS**  
 Manufacturing information about your product, you may be asked for this information if you request help or support.

Model	FF9-01	Robot System
Serial	P89K1247576	
MAC	00 15 82 13 08 5A	
Hardware Revision	2	
Firmware Version	3.10.15-1	

**HDBaseT STATUS**  
 details of the HDBaseT devices inside and connected to your system.

HDBaseT Transmitters		HDBaseT Receivers	
HDBaseT	Output (Transmitter) 1 Current Firmware Version: 7.5.7		
HDBaseT	Output (Transmitter) 2 Current Firmware Version: 7.5.7		
HDBaseT	Output (Transmitter) 3 Current Firmware Version: 7.5.7		
HDBaseT	Output (Transmitter) 4 Current Firmware Version: 7.5.7		

© 2021 All rights reserved. | Pulse Eight

Under the Hardware Details tab, you will find manufacturing information about your product such as model, serial number, MAC, hardware revision, and current firmware version installed. You may be asked for this information if you request support.

It also details the firmware versions for the HDBaseT components (transmitters and connected receivers) in your installation.

*Note: The design and features of the Web Interface are ever-evolving and may be subject to changes at any time without warning.*

## MONITORING PORTAL

### Accessing The Monitoring Portal

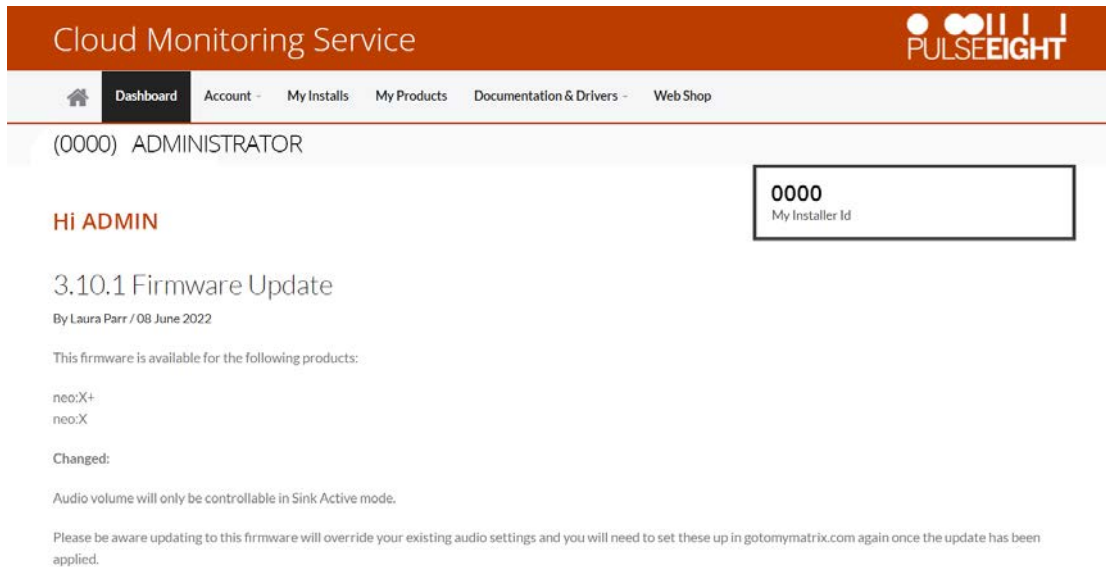

To access the monitoring portal please visit [monitoring.pulse-eight.com](https://monitoring.pulse-eight.com), click 'Login' in the top left corner, and sign in with your registered details.

Once logged in, the dashboard will display your details including your Installer ID.

**Note:** If you do not already have an Installer ID then you will need to register for a new account. Please contact your local representative or visit [monitoring.pulse-eight.com/Account/Register](https://monitoring.pulse-eight.com/Account/Register).

### My Install

Under the My Installs tab you can add projects and assign your installed systems in order to easily access and monitor certain installations.

To create an install, click the 'Add New' button and insert the details on the following screen.

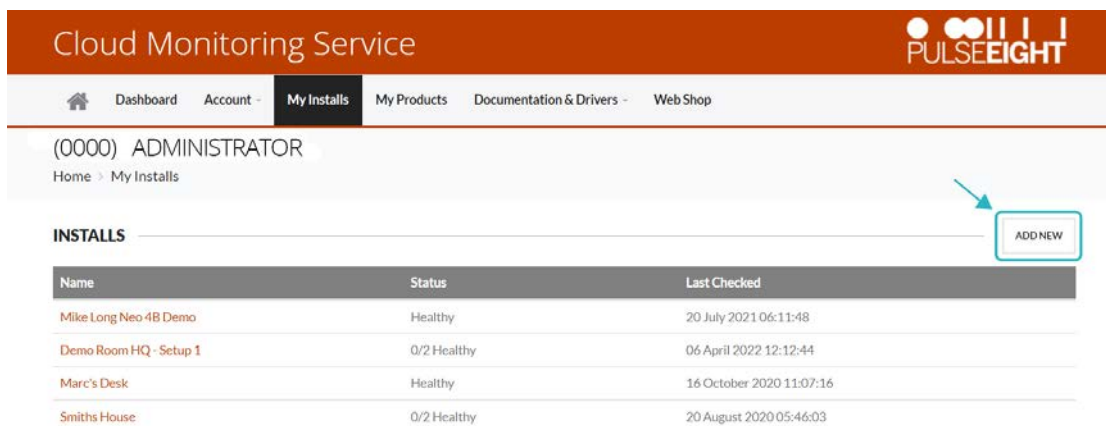

Name	Status	Last Checked
Mike Long Neo 4B Demo	Healthy	20 July 2021 06:11:48
Demo Room HQ - Setup 1	0/2 Healthy	06 April 2022 12:12:44
Marc's Desk	Healthy	16 October 2020 11:07:16
Smiths House	0/2 Healthy	20 August 2020 05:46:03

Once created, you will then be able to assign systems to the install by clicking the 'Add' button in the 'Products' section. This will then bring up a page with a dropdown menu to select a system.

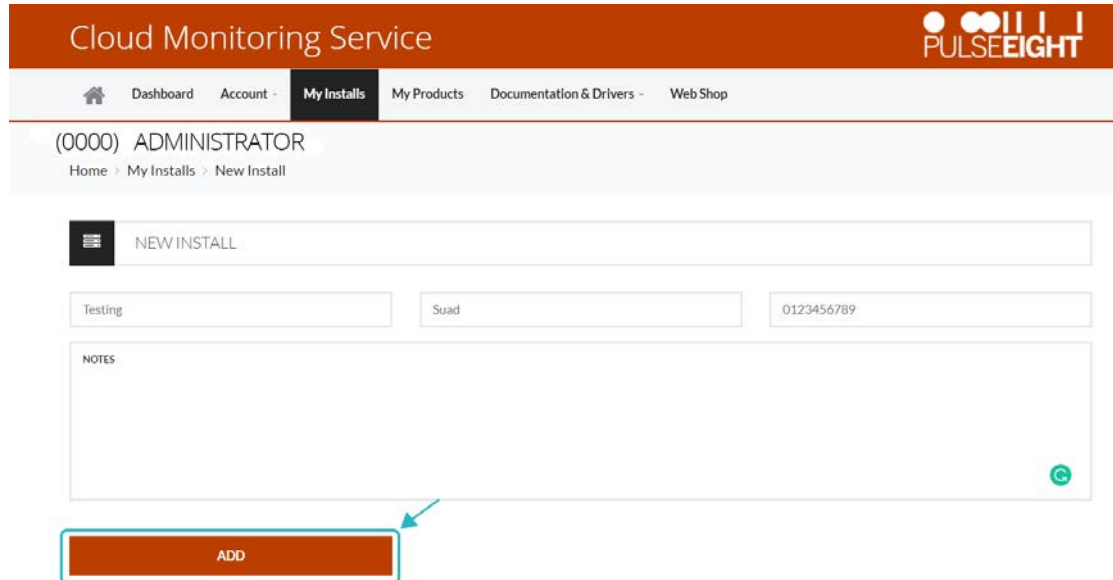

Cloud Monitoring Service 

[Dashboard](#) [Account](#) **My Installs** [My Products](#) [Documentation & Drivers](#) [Web Shop](#)

(0000) ADMINISTRATOR  
Home > My Installs > New Install

NEW INSTALL

Testing Suad 0123456789

NOTES

**ADD**

## My Products

Under the My Products tab, all your assigned Pulse-Eight systems will be listed.

 *Note: If the system you are looking for is not listed, please make sure you have added your Installer ID into the web interface of the system.*

When you click on a system, an overviewpage will appear with details of the unit such as:

- Serial Number
- Model Number
- Status
- System Temperature
- Firmware Version
- Current Uptime
- System Status - Inputs
- System Status - Outputs
- External Network Details
- Local Network Configuration
- System Commands
- Reboot Function

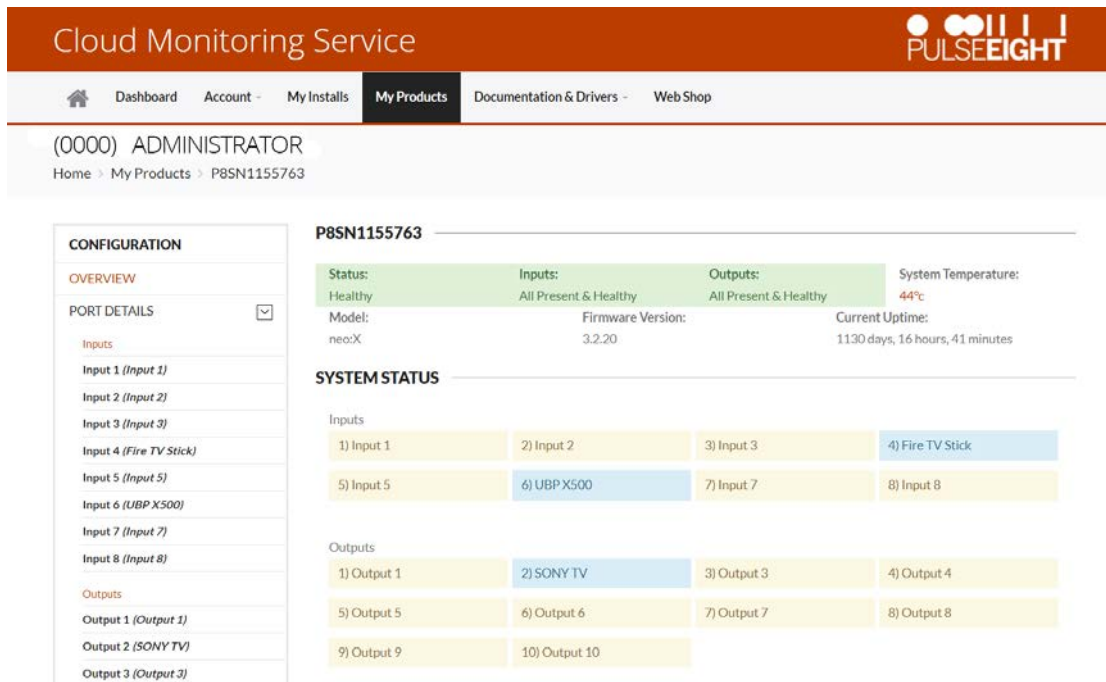

The screenshot displays the 'Cloud Monitoring Service' interface. The top navigation bar includes 'Dashboard', 'Account', 'My Installs', 'My Products' (selected), 'Documentation & Drivers', and 'Web Shop'. The user is identified as '(0000) ADMINISTRATOR' with a breadcrumb trail: 'Home > My Products > P8SN1155763'.

**CONFIGURATION**

- OVERVIEW
- PORT DETAILS 
  - Inputs
    - Input 1 (Input 1)
    - Input 2 (Input 2)
    - Input 3 (Input 3)
    - Input 4 (Fire TV Stick)
    - Input 5 (Input 5)
    - Input 6 (UBP X500)
    - Input 7 (Input 7)
    - Input 8 (Input 8)
  - Outputs
    - Output 1 (Output 1)
    - Output 2 (SONY TV)
    - Output 3 (Output 3)

**P8SN1155763**

Status: Healthy	Inputs: All Present & Healthy	Outputs: All Present & Healthy	System Temperature: 44°C
Model: neo:X	Firmware Version: 3.2.20	Current Uptime: 1130 days, 16 hours, 41 minutes	

**SYSTEM STATUS**

Inputs

1) Input 1	2) Input 2	3) Input 3	4) Fire TV Stick
5) Input 5	6) UBP X500	7) Input 7	8) Input 8

Outputs

1) Output 1	2) SONY TV	3) Output 3	4) Output 4
5) Output 5	6) Output 6	7) Output 7	8) Output 8
9) Output 9	10) Output 10		

On the left hand side, a navigation bar features more options:

- Port Details allows you to individually monitor all inputs and outputs.
- Health displays information about the system's health plus a visual history of the system's temperature over the previous month.
- Updates display the current software version and detail any updates available for the system. There is also a toggle switch to turn on 'Hotfix Updates' whereby updates are delivered automatically to the system.
- Installation Report displays all crucial information about the installation on one page. We recommend you print this page once the installation is complete to ensure the installation is correct.

**Cloud Monitoring Service** PULSEEIGHT

Dashboard Account My Installs My Products Documentation & Drivers Web Shop

(0000) ADMINISTRATOR  
Home > My Products > P8SN1155763 > Installation Report

**INSTALLATION REPORT**

**SYSTEM HEALTH**

<b>Status:</b> Healthy	<b>Inputs:</b> All Present & Healthy	<b>Outputs:</b> All Present & Healthy
<b>Model:</b> neo:X	<b>Firmware Version:</b> 3.2.20	<b>Current Uptime:</b> 1130 days, 16 hours, 48 minutes

Temperature, Day Trend

**INPUS**

Input	Name	Signal Received

**OUTPUTS**

Output	Name	Manufacturer

## Documentation & Drivers

Under the Documentation and Drivers tab you will find links to the latest third party control drivers, manuals and troubleshooting guides alongside API information.

**Cloud Monitoring Service** PULSEEIGHT

Dashboard Account My Installs My Products **Documentation & Drivers** Web Shop

**DRIVERS**

Bitwise	Elan
Control 4	RTI
Crestron	Savant
Crestron Home	URC

**DOWNLOADS**

Discovery Tool

**DOCUMENTATION**

Visit our Documentation Hub

**API**

<b>Overview</b>	Network
CEC	Port
EDID	System
IR	Misc
Monitoring	

By Laura Parr / 08 June 2022

This firmware is available for the following products:

neo:X+  
neo:X

Changed:

Audio volume will only be controllable in Sink Active mode.

Please be aware updating to this firmware will override your existing audio settings and you will need to set these up in gotomymatrix.com again once the update has been applied.

## EDID MANAGEMENT

For your home entertainment to work with each other, Extended Display Identification Data or EDID is required by the source (e.g. media box, game console, etc) to identify what is the capability of the output screen. You may need to perform a “EDID handshake” when changing EDID profiles for it to work properly.

The neo video matrix contains EDID presets to ease the setup configuration - please refer to the “Video Routing (Admin)” in the Web Interface Setup section of this manual.

Types of EDID Profile available:

- Dynamic (Lowest Common Denominator): It will set the EDID to only support the resolutions supported by all the displays connected to the outputs.
- Clone Display: Copies the same EDID as the Sink (TV or AVR) attached to the selected output. This setting is recommended when connecting an AVR to the output as it ensures the AVR’s audio capabilities are reflected on the input EDID.
- HDR/UltraHD(4K)/1080p/720p: It sets the EDID to support 4K HDR/ 4K/ 1080p/720p as the maximum resolution supported, as well as some audio support.

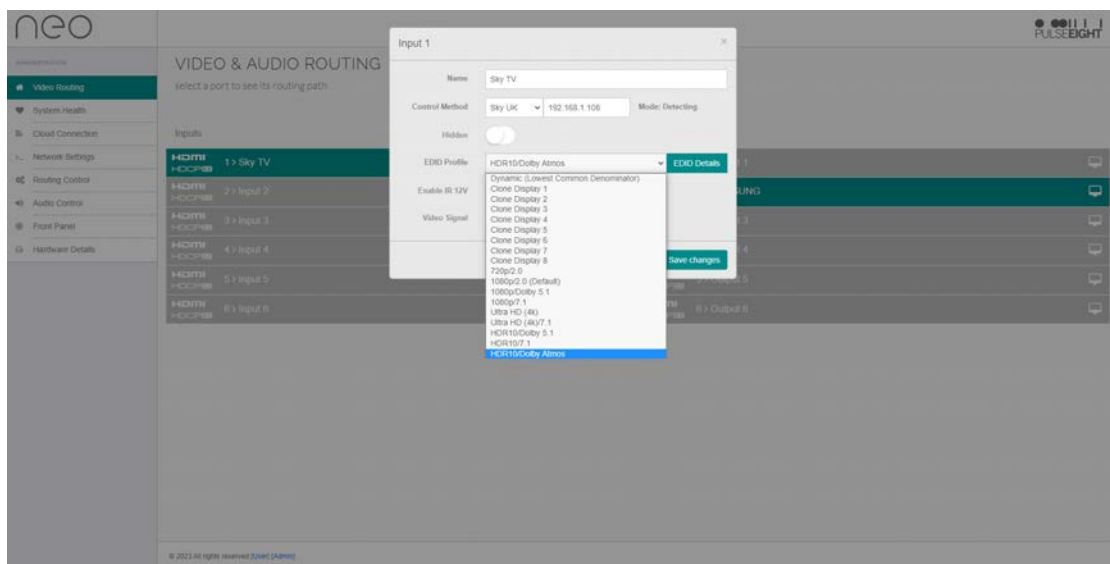

The matrix does not support individual video downscaling. If there is a mixture of displays with different resolution capabilities, then it is important to select the correct EDID profile and/or use an external downscaler.

In this scenario, if Dynamic setting is selected, then the HDMI® Input 1 will limit the resolution of the source to a maximum of 1080p. This means all displays will receive a 1080p video signal.

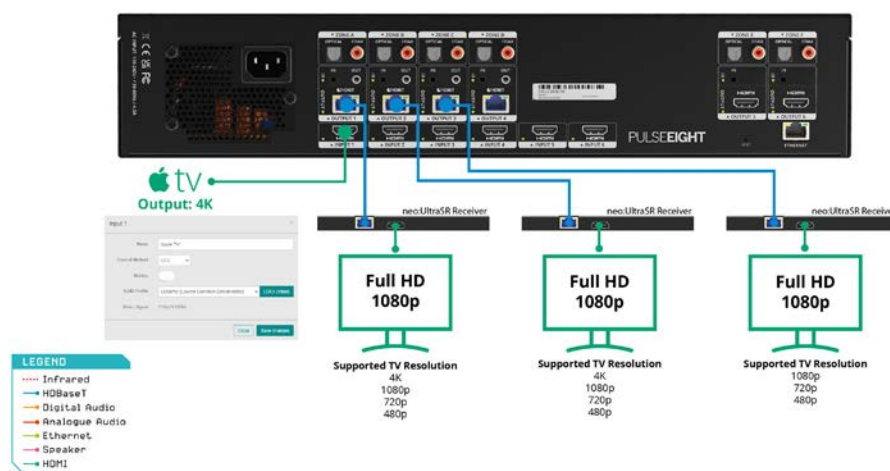



In the same scenario, selecting 4K as the EDID profile will set the resolution to a maximum of 4K that is then distributed to all connected displays. Any legacy display (supporting up to 1080p only), will likely display an error or no picture.

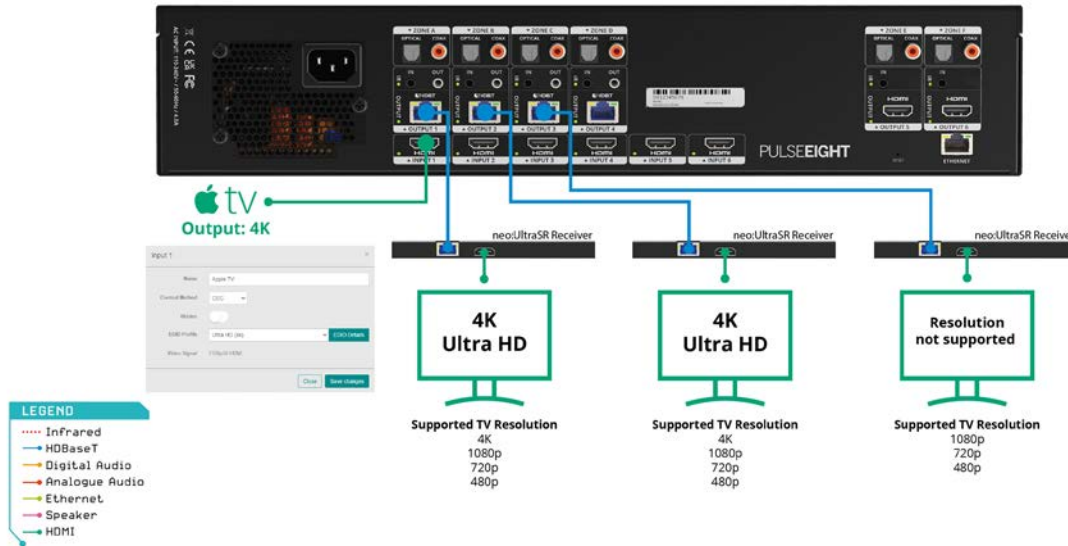

When this occurs, it is possible to use a separate 4K Downscaler (e.g. P8-HDMI2-SP2-DS) which ensures that all displays receive the maximum resolution possible.

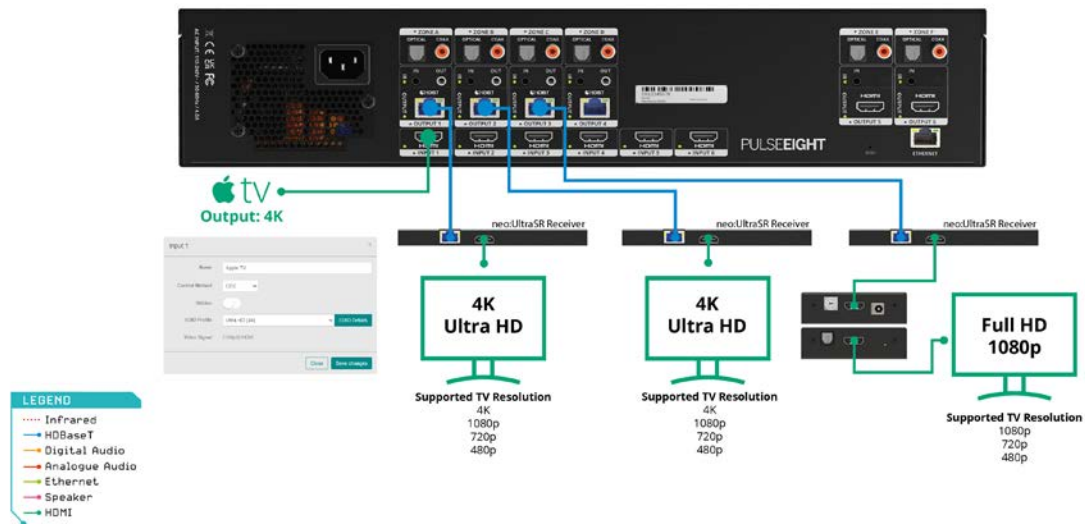

## IR BLASTING

This feature is only available with Control4.

The Pulse-Eight neo:XSR has the unique IP-to-IR logic inside, allowing it to output infrared commands (IR blasting) in a Control4 installation without the need for a cable between the EA controller and the matrix. There is no requirement for an IR optocable or complicated setup.

As long as the EA controller and the matrix are on the same network, then the driver can easily be configured to control and manage the video sources and displays flawlessly from your Control4 system through the neo:XSR matrix.

For more information, please refer to the neo:XSR driver and its documentation.

---

## LINKED DEVICE



Any neo:XSR product can easily be linked with the Pulse-Eight ProAmp8, as part of the Linked Devices option. See Output Setup Options of the Web Management section.

This feature offers the ability to control the volume via the neo:XSR (through CEC) instead of going through the ProAmp8 web UI interface.

Make sure both neo:XSR and the ProAmp8 are connected to the local network as the system needs to detect each other to make the linking possible.

## Connecting Linked Device

1. Here is the mapping and wiring diagram of an example setup.

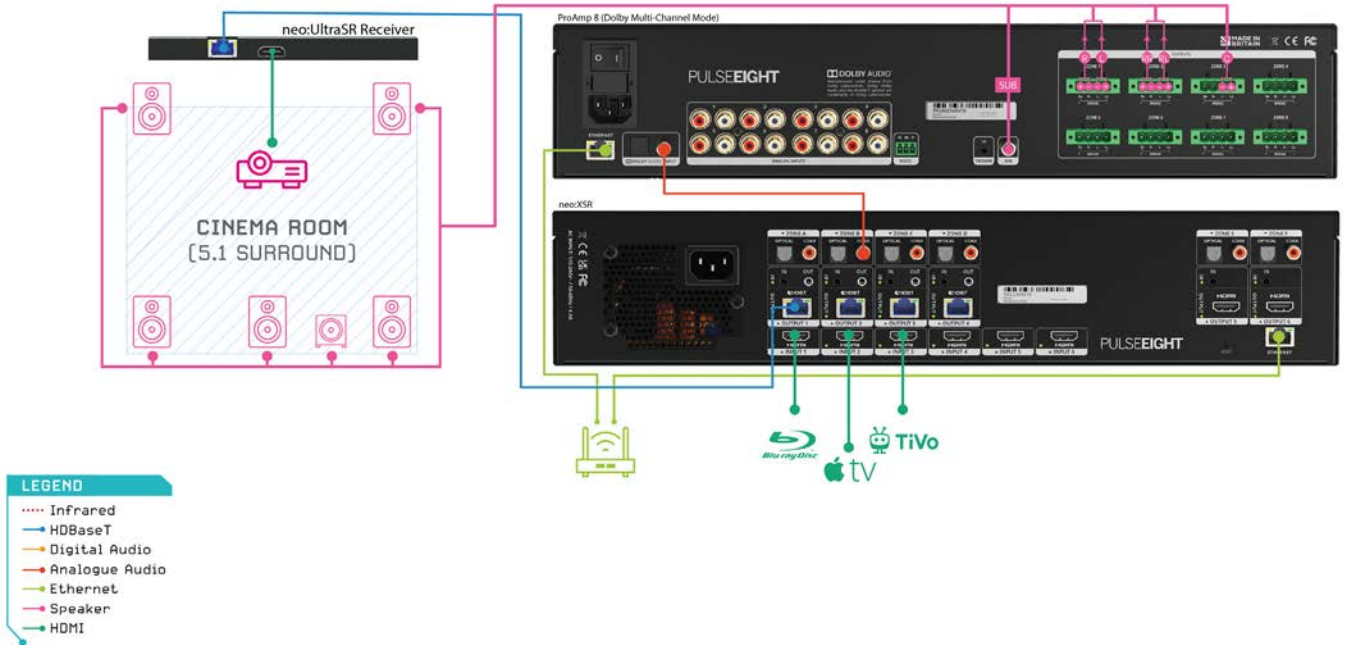

2. To use the Linked Device feature, make sure to connect to the correct output. Here is an example of the setup: a S/PDIF connector is connected via Input 9 (on the ProAmp8) and Output 2 (on the neo:XSR).

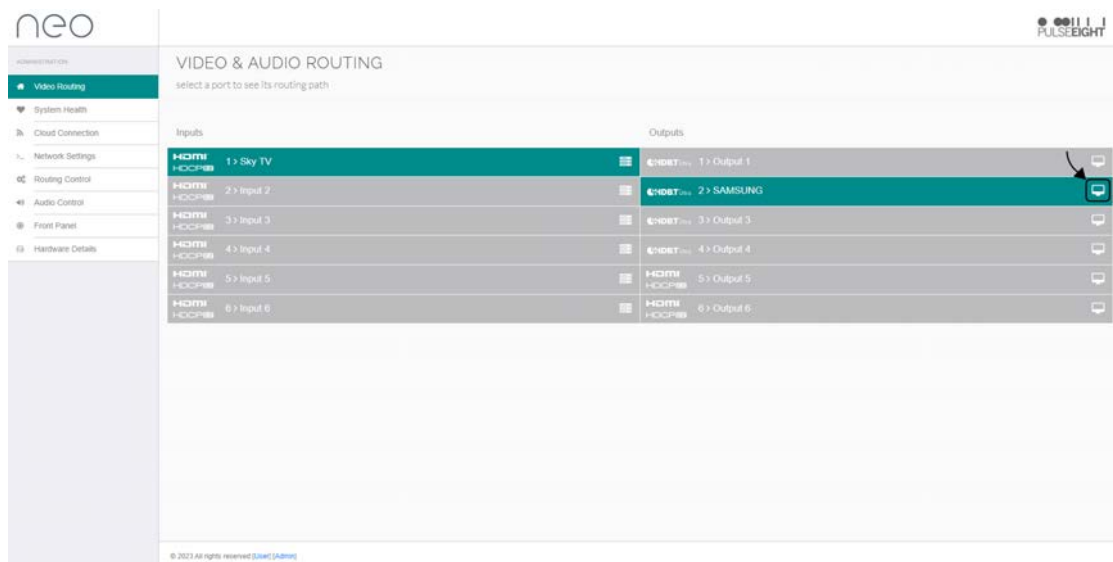

3. Next, on the neo:XSR web UI, go to Video Routing and under the Output section, click on the icon.

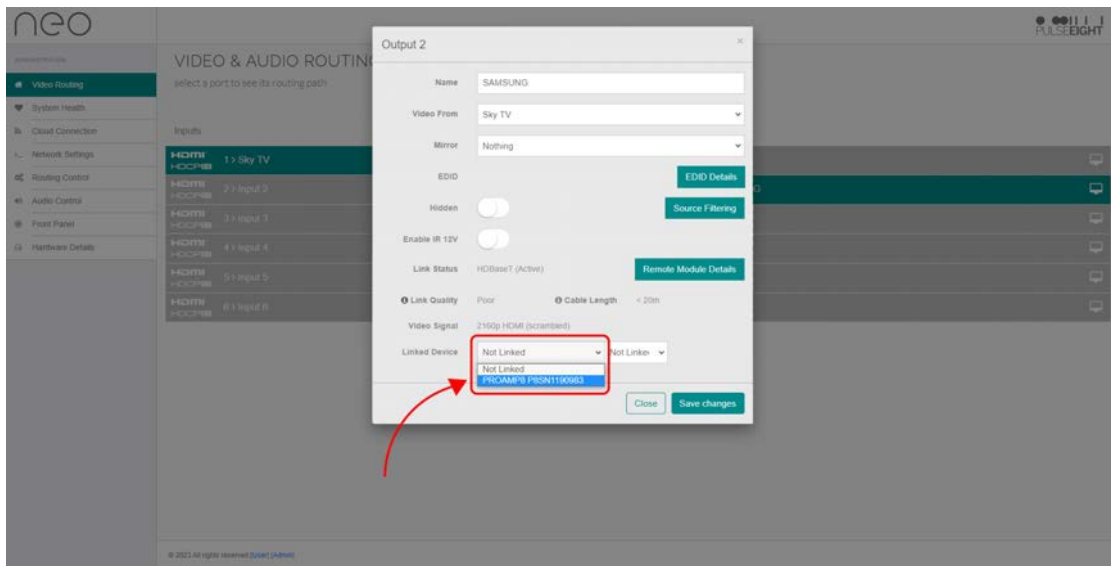

4. Once the Output window is up, select the ProAmp8 on the Linked Device section and select Input 9 (as reflected as the Input on the ProAmp8).

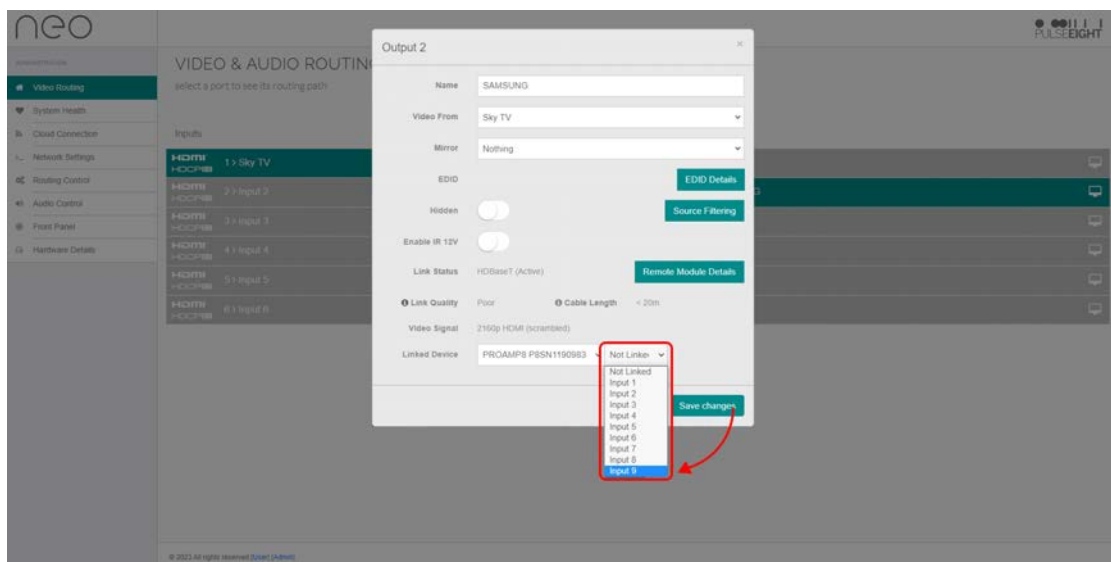

- To make sure it is working, login into the ProAmp8 web UI (Go to <http://gotomymatrix.com/> and choose ProAmp8).  
Then click the Configuration tab and click on the icon to check if it is Output 2. Make sure they are connected to the neo:XSR correct output (which is Output 2 in this case).
- The output volume control should be working over CEC once both sides can see the connection.

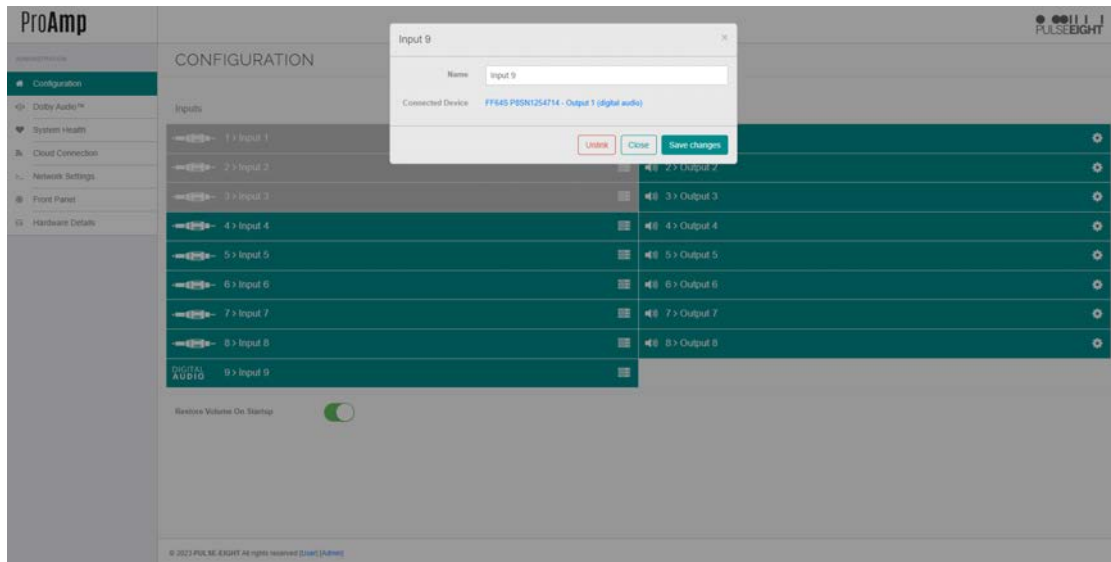

## UPDATING MATRIX FIRMWARE

You can update the firmware on your Neo Matrix by logging into Cloud Monitoring. To update your product, go to 'My Products' and find the Video Matrix you want to change. 'Updates' can be found on the bottom left side.

Click here to see what firmware the unit is currently running (circled in orange), as well as a drop down menu with a list of available firmware for this model. To change the firmware, simply select the firmware you want the matrix to use from the dropdown menu. When the unit calls home again (every hour), it will download and install the firmware. Please keep in mind that the unit will reboot during the updating process.

**IMPORTANT:** If your unit is on an older firmware and you are trying to update it we would advise not to jump to the newest update if your current firmware is more than two versions old. Please do not update more than two available versions in one go. Once the newer firmware has been applied you can then progress to the next one. For example: If your firmware is on 3.1, we would advise updating to 3.3, then 3.5 rather than going straight from 3.1 to 3.5. To clarify this is no more than 2 available versions. For example it is safe to update from 3.5 to 3.9 as 3.6-3.8 was not officially released and therefore will not cause any issues to your update.

If you want the update to apply to the unit sooner rather than waiting for the unit to next phone home, you can 'send a monitoring pulse' by logging into [gotomymatrix.com](http://gotomymatrix.com) and sending the Pulse from the Cloud Connection menu on the left once you have logged into the admin section (If you have not previously accessed this area, please consult your Pulse-Eight installation guide for the password.)

By pressing the 'send monitoring pulse now' button, the unit will immediately phone home and the update will be applied.

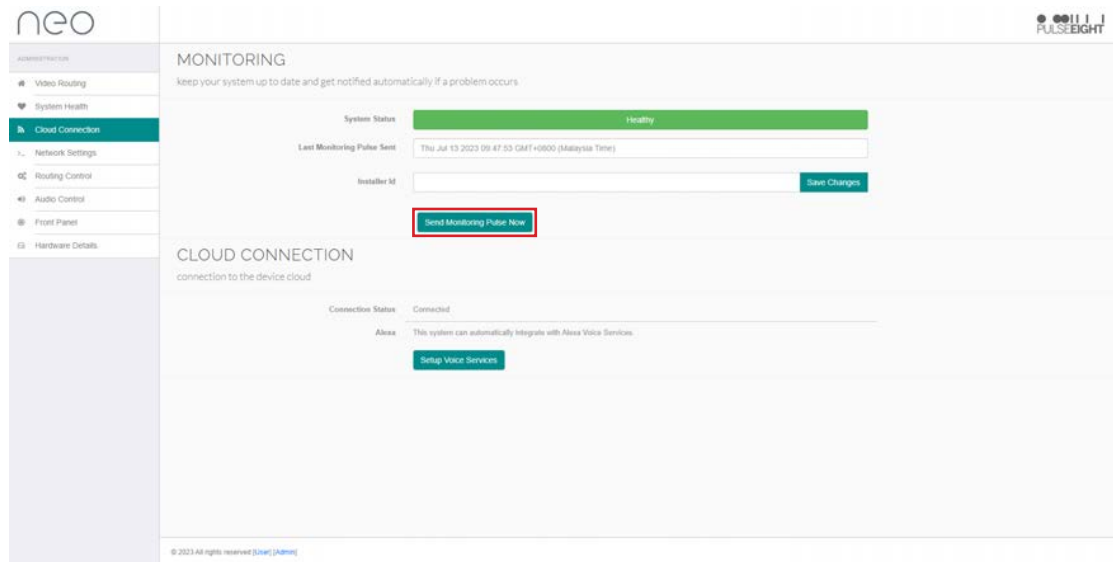

Alternatively you can contact Pulse-Eight support who offer 24 hour support Monday-Friday and they can apply the firmware update for you.

**⚠ WARNING:** While the update is being applied, please DO NOT turn off or reboot your unit or network connection. As part of the process, the unit will reboot itself. If the unit loses power or a network connection during the update, the update may fail or the unit's existing firmware may be lost.



## TROUBLESHOOTING

Should you encounter installation difficulties or issues with device communication, the following checklist of common issues and causes should help resolve your issues. If you still continue to experience issues, please contact your local representative for further assistance.

### No or Poor Picture Quality

- Connected and powered? Double check that all HDMI®, Ethernet and power cables are firmly connected to the correct ports and all devices are correctly powered.
- Cable length? Are you approaching the maximum distance of the Cat cable (e.g. 40m) if so, try adjusting the picture resolution/format, or try using an additional extender kit on the HDMI® output to go further distance. Cables bundled together may cause cross-talk and further degrade signal quality.
- Signal strength? The use of cable joins, stranded patch panels, wall outlands and stranded patch leads as interconnects between them can significantly reduce signal strength. Use solid core straight through connections wherever possible.
- If you reduce the resolution of the source (e.g. from 4K to 1080p), do you get a picture? If so, this suggests a conflicting resolution between source and display or a bandwidth capacity issue with your cable. Check all inputs and outputs share the same resolution capabilities.
- Picture 'snow' / HD 'noise' signifies a failure to fully establish a signal and can often be caused by poorly terminated RJ45 connectors or excess cable lengths. Ensure your cable is correctly wired to 568B standards.
- Pink or off-colour picture? This could be caused by an invalid EDID or the source device failing to read the EDID from the matrix. Try re-booting matrix and all source devices to force the re-reading of the EDID.
- Cable quality and condition - HDMI® cable/connectors can easily be damaged and the quality of material can vary. Always use good quality leads and cables and try swapping cables that are known to be working into the solution to see if this improves your image.

### EDID Handshake

There may be times you will need to perform an EDID Handshake on your Matrix. This is often after a new piece of equipment has been introduced to your setup or any changes have occurred.

To do an EDID Handshake:

1. Turn off the Matrix and all Sources
2. Turn on all TVs, and make sure these are not set to standby
3. Wait 45 seconds
4. Power on Matrix and wait for x3 Green Lights on the front panel
5. Wait a further 45 seconds
6. Turn on all sources

### No Sound on Speaker

Make sure that you are setting the matrix to Sink or Source mode and that the wiring is correct.

For a Linked Device (ProAmp8), check the following:

1. When you first install the matrix, the unit is in Sink mode passive. You need to change it to 'active' to get control of volume.
2. Make sure the port is linked to the correct one (please see step 5 in the Linked Device section).
3. Toggle the ARC settings between HDMI®, Optical & Disabled (please see step 6 in the Linked Device section).

 *Note: This occurs only when using S/PDIF & Digital Coax outputs.*



### Infrared Not Functioning

1. Make sure to use the compatible IR flasher/receiver for this video matrix.
2. Check and see if the LED beside the IR port is lighting up. It signifies whether the IR connection is working.
3. If the IR bud is not receiving or transmitting, test it out with a different port or swap with another IR bud to deduce the problem

 *Note: Do not mix and match 12V or 5V to different video matrixes as they could cause irreparable damage.*

### IR Control

- Are the IR emitters and receivers correctly positioned to allow infrared signals to be transmitted and received? Emitters should be fixed firmly over infrared sensors of sources. Receivers should be attached or next to displays ensuring a clear line of sight to the remote control used to operate. Each IR port has an LED, when correctly installed the LED will flash red/green when IR is transmitting or receiving.
- Is your remote control powered and sending a signal? As IR is invisible to the naked eye, a good trick to check whether your remote is transmitting a signal is by viewing the remote handset sensor through a digital camera/camera phone. The sensor should flash when a button on the handset is held down and this is not supported by all phone cameras.
- IR signal dropout can be experienced due to exterior emissions of infrared radiation. Ensure emitters and receivers are away from direct sunlight. Halogen lighting and plasma screens may also interfere with IR signals.

### Can't See Other Unit When Going to Link The Devices

1. Make sure both neo:X+ and the ProAmp8 are connected to the local network. The system needs to detect each other to make the linking possible.
2. If both units are on the latest firmware and it's still not visible, please try the following:
  - a hard refresh (CTRL + R or CTRL F5)
  - run on another web browser
  - Or, clear the cache for your web browser.

### Linked Device Option Is Not Available or Visible

Update both ProAmp8 & neo:XSR to the latest firmware and perform a power cycle (reboot both).

## Back Panel LED Values

There are several debug LEDs next to the input and output ports that can help with any further troubleshooting.



- A IR:**
  - OFF - No IR.
  - GREEN (Flashing) - IR signal present, either Receiver (in) or Flasher (out).
  - RED - IR signal present on emitter port (OUT).
- B HDBT RJ45 Left:**
  - OFF - No HDBT Link.
  - AMBER - HDBT Link established.
- HDBT RJ45 Right:**
  - OFF - No Video
  - GREEN (Blink) - Video Present (No HDCP).
  - GREEN (Solid) - Video Present (HDCP).
- C HDBT Output:**
  - OFF - No HDBT RX connected.
  - GREEN - HDBT RX connected / PoH enabled.
- D HDMI® Input:**
  - OFF - No Signal.
  - GREEN - HDMI® +5V and Signal.
- E HDMI® Output:**
  - OFF - No Signal.
  - GREEN - HDMI® Hotplug.
- F ETH RJ45 Left:**
  - OFF - No ethernet.
  - AMBER (Blinking) - Activity on Network.
- ETH RJ45 Right:**
  - OFF - No Ethernet.
  - GREEN - Connected to Network.

## SUPPORTED 4K RESOLUTIONS

The neo:XSR has an 18Gbps backplane that allows it to accept and route HDMI® 2.0 formats within the matrix.

Below is the list of 4K/UHD resolution formats supported over the HDBaseT 2.0 outputs by using Display Stream Compression (DSC), a highly-advanced compression standard providing true visually-lossless performance with zero latency.

RESOLUTION	FRAME RATE (FPS)	CHROMA	DEEPCOLOUR/ BIT DEPTH	HDR	HDBASET 2.0
3840x2160(UHD)	24, 35, 30	4:2:0	8 Bit	No	Yes
			10 Bit	Yes	Yes
			12 Bit	Yes	Yes
		4:2:2	8 Bit	No	Yes
			10 Bit	Yes	Yes - with DSC
			12 Bit	Yes	Yes - with DSC
	4:4:4	8 Bit	No	Yes	
		10 Bit	Yes	Yes - with DSC	
		12 Bit	Yes	Yes - with DSC	
	50, 60	4:2:0	8 Bit	No	Yes
			10 Bit	Yes	Yes - with DSC
			12 Bit	Yes	Yes - with DSC
		4:2:2	8 Bit	No	Yes - with DSC
			10 Bit	Yes	Yes - with DSC
			12 Bit	Yes	Yes - with DSC
4:4:4	8 Bit	No	Yes - with DSC		

## MANUAL VERSION HISTORY

V1.0 - 14th September 2023. The first version of the user manual.

V1.1 - 9th February 2024. Minor update on the Safety Precaution and Intallation section.

## WARRANTY PROCEDURE

The following policies covers all Pulse-Eight products.

Unless otherwise instructed, please do not open any of our products. Doing so will invalidate your warranty. As part of the troubleshooting procedure, you may be instructed to open the device, but you can only proceed with this once consent has been given.

To open a support ticket, please visit: [www.pulse-eight.com/support](http://www.pulse-eight.com/support).

**Please Note:** Warranty cover for ALL products starts from date of receipt of goods NOT date of installation. Should we find that your product does need replacing, we will send your replacement directly to the distributor you purchased from, if not purchased directly from Pulse-Eight.

From 1st April 2022, any products purchased will have new warranty lengths. The length of warranty is determined by the type of product purchased. Our cover can be broken down into 3 categories:

### Gold, Silver, and Bronze.

#### **GOLD: Pulse-Eight Audio and Video Matrices**

- 5-year warranty as standard
  - 3-year advanced replacements
  - 2-year return to base for repair

#### **SILVER: Pulse-Eight Amps, Extender Sets, and Accessories**

- 3-year warranty as standard
  - 1-year advanced replacements
  - 2-year return to base for repair

#### **BRONZE: IR, Cables, Brackets, and our Tech Tools**

- 1-year advanced replacements

#### **Pulse-Eight Current Product—Within the advanced replacement warranty year(s)**

1. Contact support via phone or a support ticket. Pulse-Eight will try to help troubleshoot and resolve the issue remotely.
2. If unable to resolve the fault remotely and the unit needs replacing an advanced replacement will be raised with the installer who purchased it. If you purchased from a distributor you will need to return to your distributor and they will contact Pulse-Eight to get the RMA raised. All distributor advanced replacements will be sent to the distributor and cannot be sent directly to their installer.

#### **Pulse-Eight Current Product—Within return to base warranty**

1. Contact support via phone or a support ticket. Pulse-Eight will try to help troubleshoot and resolve the issue remotely.
2. If unable to resolve the fault remotely and the unit needs to be repaired, an RMA will be raised with the installer if purchased direct from Pulse-Eight. Or if purchased from a distributor, the installer will be directed back to their distributor who will raise an RMA.

#### **Pulse-Eight Products Purchased Before 1st April, 2022.**

Please visit: [Warranty Page](#). Or Contact support via phone, opening a support ticket or emailing [support@pulse-eight.com](mailto:support@pulse-eight.com).

## WARRANTY TERMS & CONDITIONS

### **IMPORTANT INFORMATION ABOUT YOUR RIGHTS AND OBLIGATIONS, AS WELL AS LIMITATIONS AND EXCLUSIONS THAT MAY APPLY TO YOU. YOUR RIGHTS AND THIS LIMITED WARRANTY**

This Limited Warranty gives you specific legal rights. You may also have other legal rights that vary by state, province, or jurisdiction. The disclaimers, exclusions, and limitations of liability under this Limited Warranty will not apply to the extent prohibited by applicable law. For a full description of your legal rights, you should refer to the laws applicable in your jurisdiction and you may wish to contact a relevant consumer advisory service.

#### **1. WHAT THIS LIMITED WARRANTY COVERS; PERIOD OF COVERAGE**

Pulse-Eight Limited ("Pulse-Eight"), 8-12 Alder Hills, Poole, BH12 4AL, UK, warrants to the owner of the enclosed product that the product contained in this box ("Product") will be free from defects in materials and workmanship for a period of three years from the date of delivery following the original purchase (the "Warranty Period"), or if this product has been professionally installed, the warranty start date is from the date your installer purchased the item, not your system commissioning date. Please check with your installer for their purchase date. If the Product fails to conform to this Limited Warranty during the Warranty Period, Pulse-Eight will, at its sole discretion, either (a) repair or replace any defective Product or component; or (b) accept the return of the Product and refund within 45 days of return the money actually paid by the original purchaser for the Product. Repair or replacement may be made with a new or refurbished product or components, at Pulse-Eight's sole discretion.

If the Product or a component incorporated within it is no longer available, Pulse-Eight may replace the Product with a similar product of similar function, at Pulse-Eight's sole discretion. This is your sole and exclusive remedy for breach of this Limited Warranty. Any Product that has either been repaired or replaced under this Limited Warranty will be covered by the terms of this Limited Warranty for the longer of ninety (90) days from the date of delivery or the remaining Warranty Period. This Limited Warranty is transferable from the original purchaser to subsequent owners, but the Warranty Period will not be extended in duration or expanded in coverage for any such transfer.

#### **2. TOTAL SATISFACTION RETURN POLICY**

If you are the original purchaser of the Product and you are not satisfied with this product for any reason, you may return it in its original condition within thirty (30) days of the original purchase and receive a full refund. If this is a professionally installed product, you must check with your installer regarding their own returns policy.

#### **3. WARRANTY CONDITIONS; HOW TO GET SERVICE IF YOU WANT TO CLAIM UNDER THIS LIMITED WARRANTY**

Before being able to claim under this Limited Warranty, the owner of the Product must (a) notify Pulse-Eight of the intention to claim by emailing [support@pulse-eight.com](mailto:support@pulse-eight.com) during the Warranty Period and providing a description of the alleged failure, and (b) comply with Pulse-Eight's return shipping instructions, and (c) ship the Product at owner's cost (except where prohibited by applicable law) to Pulse-Eight for repair or replacement. Pulse-Eight will have no warranty obligations with respect to a returned Product if it determines, in its reasonable discretion after examination of the returned Product that the Product is an Ineligible Product (defined below). Pulse-Eight will bear all costs of return shipping to the owner, except with respect to any Ineligible Product, for which the owner will bear all shipping costs.

#### **4. WHAT THIS LIMITED WARRANTY DOES NOT COVER**

This warranty does not cover the following (collectively "Ineligible Products"): Products marked as "sample" or sold "AS IS"; or Products that have been subject to: (a) modifications, alterations, tampering, or improper maintenance or repairs; (b) handling, storage, installation, testing, or use not in accordance with the Installation Guide or other instructions provided by Pulse-Eight; (c) abuse or misuse of the Product; (d) breakdowns, fluctuations, or interruptions in electric power or the telecommunications network; or (e) Acts of God, including lightning, fire, flood, tornado, earthquake, or hurricane. This warranty does not cover consumable parts, including batteries unless damage is due to defects in materials or workmanship of the Product, or software (even if packaged or sold with the product). Pulse-Eight recommends that you use only authorized service providers for maintenance or repair. Unauthorized use of the Product or software can impair the Product's performance and may invalidate this Limited Warranty. Pulse-Eight does not warrant that operation of the Product will be error-free or uninterrupted or that the Product will in every case process all data correctly.

## 5. DISCLAIMER OF WARRANTIES

Except as stated above in this limited warranty, and to the maximum extent permitted by applicable law, Pulse-Eight disclaims all express, implied, and statutory warranties and conditions with respect to the product, including the implied warranties of merchantability, fitness for a particular purpose. To the maximum extent permitted by applicable law, also limits the duration of any implied warranties or conditions to the duration of this limited warranty.

## 6. LIMITATION OF DAMAGES

In addition to the above warranty disclaimers, in no event will Pulse-Eight be liable for any consequential, incidental, exemplary, or special damages, including any damages for lost data or lost profits, arising from or relating to this limited warranty or the product, and Pulse-Eight's total cumulative liability arising from or related to this limited warranty or the product will not exceed the amount actually paid for the product by the original purchaser.

## 7. LIMITATION OF LIABILITY

Pulse-Eight disclaims all liability of any kind of Pulse-Eight's suppliers. The Pulse-Eight online services ("services") may provide you with information ("product information") regarding your product's performance and/or peripherals connected to your product ("product peripherals"). The type of product peripherals that may be connected to your product may change from time to time. Without limiting the generality of the disclaimers above, all product information is provided for your convenience, "as is", and "as available". Pulse-eight does not represent, warrant, or guarantee that product information will be available, accurate, or reliable. You use all product information, the services, and the product at your own discretion and at risk. You will be solely responsible for (and Pulse-Eight disclaims) any and all loss, liability, or damages, including to your HVAC system, plumbing, home, product, product peripherals, computer, mobile device, and all other items and pets in your home, resulting from your use of the product information, services, or product. The product information provided by the services is not intended as a substitute for direct means of obtaining the information.

## 8. VARIATIONS THAT MIGHT APPLY TO THIS LIMITED WARRANTY

Some jurisdictions do not allow limitations on how long an implied warranty lasts or exclusions/limitations on incidental or consequential damages, so some of the limitations set out above may not apply to you.

## COPYRIGHT NOTICE

No part of this document may be reproduced, transmitted, transcribed, stored in a retrieval system, or any of its parts translated into any language or computer file, in any form or by any means (electronic, mechanical, magnetic, optical, chemical, manual, or otherwise) without express wrote permission and consent from Pulse-Eight Limited.

© Copyright 2023 Pulse-Eight Limited. All Rights Reserved.

Dolby and Dolby Atmos are either trademarks or registered trademarks of Dolby Laboratories in the United States and/or other countries.

The Adopted Trademarks, HDMI High-Definition Multimedia Interface, HDMI trade dress, and HDMI Logos are trademarks or registered trademarks of HDMI Licensing Administrator, Inc. in the United States and other countries.

Other trademarks, registered trademarks, and trade names may be used in this document to refer to either the entities claiming the marks and names or their products. Pulse-Eight disclaims any proprietary interest in the marks and names of others.

NOTES

A series of horizontal dotted lines for taking notes, filling the majority of the page.