



ProAudio16RS

DSP AUDIO MATRIX

PULSEEIGHT

ProAudio16RS
DSP AUDIO MATRIX

■ SYSTEM ■ NETWORK ■ IO / DB

USER MANUAL

P8-PROAUDIO16RS

V1.1

 **MADE IN
BRITAIN**

CONTENTS

Introduction	3
Features	3
Inside The Box (Kit)	3
Specifications	4
Safety Precaution	5
Panel Descriptions	6
Audio Extender Transmitters	7
Overview - Audio Routing Capabilities	8
Installation	9
Wiring Diagram	12
Control Setup	13
Paging And Doorbell	16
Audio Output Zone Settings	17
Lock Zone	18
Setting Up A Subwoofer	19
Setting Minimum/Maximum Volume	20
Troubleshooting	21
Manual Version History	21
Warranty Procedure	22
Warranty Terms & Conditions	23
Notes	25

INTRODUCTION

The ProAudio16RS is a new version of our popular ProAudio16 audio matrix switch that allows audio extension from a remote source up to 200m over a Cat 5e/6/7 cable (656ft).

The ProAudio16RS DSP Pre-Amp Audio Matrix features 48 audio inputs (16x Stereo L/R, 8x Cat 5e (Remote Source), 8x Optical, 16x Digital Coax) alongside 16 zone outputs (16x Stereo L/R and 16x Digital Coax), enabling simultaneous audio distribution to multiple zones. Each output zone can be enhanced with built-in features including 5 band equalizer per zone, adjustable volume and gain settings, subwoofer control, serial and TCP/IP control, lip sync delay and much more.

Pulse-Eight's ProAudio™ series offers a range of versatile DSP preamp audio matrix switches with innovative features and unmatched capabilities designed for the custom install AV market. It provides a world class audio experience with maximum flexibility and capability, plus the largest selection of DSP preamp model configurations.

FEATURES

- 48 Audio Inputs: 16x Stereo L/R, 8x Cat 5e (Remote Source), 8x Optical, 16x Digital Coax
- 16 Zone Outputs: 16x Stereo L/R, 16x Digital Coax
- Ability to extend digital audio from a source in a remote location (zone), up to 200 m (656 ft) over a Cat 5e/6/7 cable.
- Volume, Balance, Bass, Treble and 5 Band Equalizer control of analog and digital audio.
- Volume range: +24dB to -99.5dB, and full mute (-115dB), with 0.5dB step resolution.
- Master volume to control all zones simultaneously (+24dB to -99.5dB), and full mute.
- Tone / EQ ranges: +20dB to -20dB, with 0.5dB step resolution.
- Gain settings (+/-24dB) for all analog and digital inputs.
- Zone gain settings (+/-24dB) for each zone.
- Lip sync delay from 0 to 170ms, per zone and/or per input.
- Audio format conversion: Digital inputs (2-Channel PCM) are automatically converted to analog audio. (Does not downmix Dolby5.1 or DTS to analog audio, but does pass multichannel audio to the S/PDIF digital outputs)
- Both analog and digital audio is available simultaneously on the outputs.
- Controlled through TCP/IP and/or Bi directional RS 232.
- Drivers available for all major control systems.

INSIDE THE BOX (KIT)

- 1 x ProAudio16RS Chassis
- 1 x Quick Start Guide
- 1 x Power Cord
- 1 x Rack Mounting Kit
- 8 x Audio Extender Transmitters



8 x Audio Extender Transmitters



Power Cord

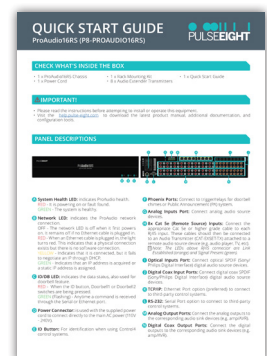

Quick Start Guide



ProAudio16RS



Rack Mounting Kit

SPECIFICATIONS

Inputs	16x Stereo L/R, 8x Cat 5e (Remote Source), 8x Optical, 16x Digital Coax
Outputs	16x Stereo L/R, 16x Digital Coax
12V Trigger	No
Doorbell/ Paging	2x Inputs
Lip-sync	Up to 170ms per zone and/or per input
Audio Outputs Settings	<ul style="list-style-type: none"> • Volume Range: +24dB to -99.5dB, and full mute (-115dB), with 0.5dB step resolution. Individual zone and master (all zones) control. • Bass Range: -20db to +20db, 0.5db steps • Treble Range: -20db to +20db, 0.5db steps • Equalizer: 5 Band EQ per zone
Control Settings	<ul style="list-style-type: none"> • Subwoofer Control: Yes • Input Gain: -24dB to +24dB • Output Gain: -24dB to +24dB
Power Handling	<ul style="list-style-type: none"> • Coax Input Levels: 200mV - 7.0V (PC card compatible) • Coax Output Level: 500mV nominal into 75 ohms
Frequency Response	5Hz - 20kHz @+/-0.1dB S.N.
Signal to Noise Ratio	> 85dB, 5Hz-20kHz
Analog Input Voltage	2.0 Vrms
Input Impedance	10K Ohms
Audio Modes	PCM, Dolby Digital 5.1, DTS. (multi-channel modes are pass thru only, the switches do not downmix).
Format conversion	Yes - Digital-to-Analog and Analog-to-Digital are supported. <ul style="list-style-type: none"> • <i>Limited to 2 channel audio conversions only.</i> • <i>Analog-to-Digital is only supported when coax output is mirroring the stereo outputs.</i>
Analog Output Voltage	2.0 Vrms
Ethernet Ports	1 x RJ45 (TCP/IP control only)
RS-232 Ports	1x DB9 (control only)
Operating Humidity	5 to 90% RH (no condensation)
Operating Temperature	0 to +35°C (32 to +95°F)
Storage Temperature	-20°C to 60°C (-4°F to 140°F)
Power Input	IEC C14 socket
Power Rating	110-240V, 1.0A, 50/60Hz
Rack Spacing	2U
Certifications	UKCA, CE, FCC (SDoC), RoHS
Included Accessories	8x Audio Transmitters, Rack mounting accessories, Power cable
Driver	Control 4, Elan, Savant.
Dimensions (W x H x D)	17.5" x 3.20"(2U) x 8.70" (44cm x 8cm x 22cm)
Weight	8.97 lb (4.1 Kg)
Box Dimensions	21.65" x 11.81" x 5.51" (55cm x 30cm x 14cm)

SAFETY PRECAUTION

Please read the instructions before attempting to install or operate this equipment.

Please keep the following in mind as you unpack and install this equipment:

- Always follow basic safety precautions to reduce the risk of fire, electrical shock, and injury.
- To prevent fire or shock hazards, do not expose the unit to rain, or moisture or install this product near water.
- Never spill liquid of any kind on or into this product.
- Where possible, install the ProAudio towards the top of the rack to avoid the unit overheating.
- Only use the supplied IEC cable.
- Never push any objects into this product through any openings or empty slots in the unit as you may damage parts inside and/or cause an electrical shock.
- Do not allow anything to rest on the power cabling and avoid putting the weight of any kind on it.
- To protect the unit from overheating do not block any vents or openings in the unit housing that provides ventilation. Allow sufficient space for air to circulate around the unit.
- This product is intended for use in a clean (dust-free) residential environment.

Ventilation

It's important to keep the product well ventilated when installing this Pulse-Eight ProAudio.

Any electronic equipment will generate heat. A well-ventilated area helps to disperse the heat. If placed in a poorly ventilated area, your equipment may heat up and cause irreparable damage to the circuitries.

Allowing systems to run for prolonged periods under high temperatures will break down circuitry and electrical component. It also applies if the device is left in the path of direct sunlight or near any heat source.

Dust tends to accumulate and will disrupt the fan and electronics system. Dust particles contain various compositions like water, oil, and other minerals or chemicals. Having them in your electronic device can sometimes cause a signal error or degradation to the internal chips and circuitries. Because we cannot accurately predict how or when they can affect your device, we highly recommend that you keep Pulse-Eight products not only in a well-ventilated area but also as clean as possible.

In some cases, insects or reptiles can make nests near or inside the electronic casing. Whilst we design our products to maximize the protection of internal electronics, please be aware that insects and reptiles can be drawn to these types of habitats. In the unlikely event, this does happen, this will lead to poor ventilation inside the unit, and it will be unable to disperse heat effectively.

Finally, whenever possible, do not stack audio and video matrixes together. Leave enough space in between each unit in order to provide good airflow.

FCC Warning

This equipment has been tested and found to comply with the limits for a Class B digital device, pursuant to part 15 of the FCC Rules. These limits are designed to provide reasonable protection against harmful interference in a residential installation. This equipment generates, uses and can radiate radio frequency energy and, if not installed and used in accordance with the instructions, may cause harmful interference to radio communications. However, there is no guarantee that interference will not occur in a particular installation. If this equipment does cause harmful interference to radio or television reception, which can be determined by turning the equipment off and on, the user is encouraged to try to correct the interference by one or more of the following measures:

- Reorient or relocate the receiving antenna.
- Increase the separation between the equipment and receiver.
- Connect the equipment into an outlet on a circuit different from that to which the receiver is connected.
- Consult the dealer or an experienced radio/TV technician for help.

PANEL DESCRIPTIONS

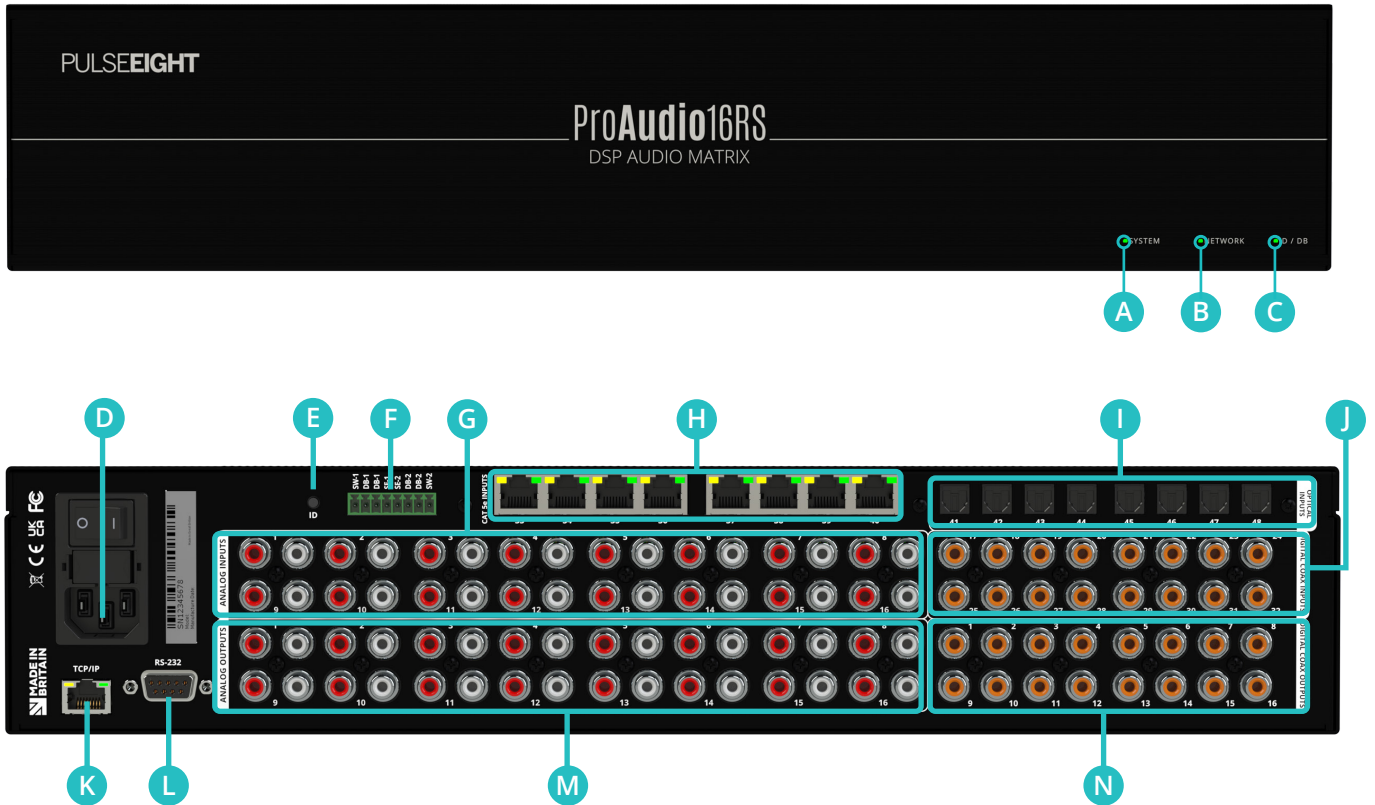

A System Health LED: indicates ProAudio health.

RED - It is powering on or fault found.

GREEN - The system is healthy.

B Network LED: indicates the ProAudio network connection.

OFF - The network LED is off when it first powers on. It remains off if no Ethernet cable is plugged in.

RED - When an Ethernet cable is plugged in, the light turns red. This indicates that a physical connection exists but there is no software connection.

YELLOW - Indicates that it is connected, but it fails to negotiate an IP through DHCP.

GREEN - Indicates that an IP address is acquired or a static IP address is assigned.

C ID/DB LED: indicates the data status, also used for doorbell feature.

RED - When the ID button, Doorbell1 or Doorbell2 switches are being pressed.

GREEN (Flashing) - Anytime a command is received through the Serial or Ethernet port.

- D Power Connector:** is used with the supplied power cord to connect directly to the main AC power (110V - 240V).
- E ID Button:** For identification when using Control4 control systems.
- F Phoenix Ports:** Connect to trigger/relays for doorbell chimes or Public Announcement (PA) system.
- G Analog Inputs Port:** Connect analog audio source devices.
- H 8x Cat 5e (Remote Source) Inputs:** Connect the appropriate Cat 5e or higher grade cable to each RJ45 input. These cables should then be connected to an Audio Transmitter (CAT-EXSET-TX) attached to a remote audio source device (e.g. audio player, TV, etc).
- I Optical Inputs Port:** Connect optical SPDIF (Sony/Philips Digital Interface) digital audio source devices.
- J Digital Coax Input Ports:** Connect digital coax SPDIF (Sony/Philips Digital Interface) digital audio source devices.
- K TCP/IP:** Ethernet Port option to connect to third-party control systems.
- L RS-232:** Port Serial option to connect to third-party control systems.
- M Analog Output Ports:** Connect the analog outputs to the corresponding audio sink devices (e.g. amp/AVR).
- N Digital Coax Output Ports:** Connect the digital outputs to the corresponding audio sink devices (e.g. amp/AVR).

AUDIO EXTENDER TRANSMITTERS



- A S/PDIF (Sony/Philips Digital Interface Format)** - Connect to Toslink optical S/PDIF audio output of source device (e.g. DVD player, TV).
- B SELECTOR** - Adjust to select either Coax or S/PDIF (Optical).
- C COAX** - Connect to coaxial S/PDIF audio output of source device (e.g. DVD player, TV).
- D DC 5V** - Connect the supplied barrel-to-USB cable to a compliant 5V USB power supply.
- E CAT 5e OUT Port** - To link the transmitter to the Cat 5e (Remote Source) input on the ProAudio16RS with a Cat 5e cable.

OVERVIEW - AUDIO ROUTING CAPABILITIES

The ProAudio16RS DSP Pre-Amp Audio Matrix features 48 audio inputs (16x Stereo L/R, 8x Cat 5e (Remote Source), 8x Optical, 16x Digital Coax) and 16 audio zone outputs (16 Stereo L/R and 16 Digital Coax). Any audio input can be routed to any audio output, including digital to analog conversion. Audio downmix (multi-channel to stereo conversion) is not supported.

Note that Analog to Digital conversion is only supported when the digital output port is set to mirror its respective analog output port.

The diagram below described the basic audio routing capabilities of the ProAudio16RS.

(L) (R) = Analog Stereo Connection (S) = Coax SPDIF Connection [] = Optical SPDIF Connection

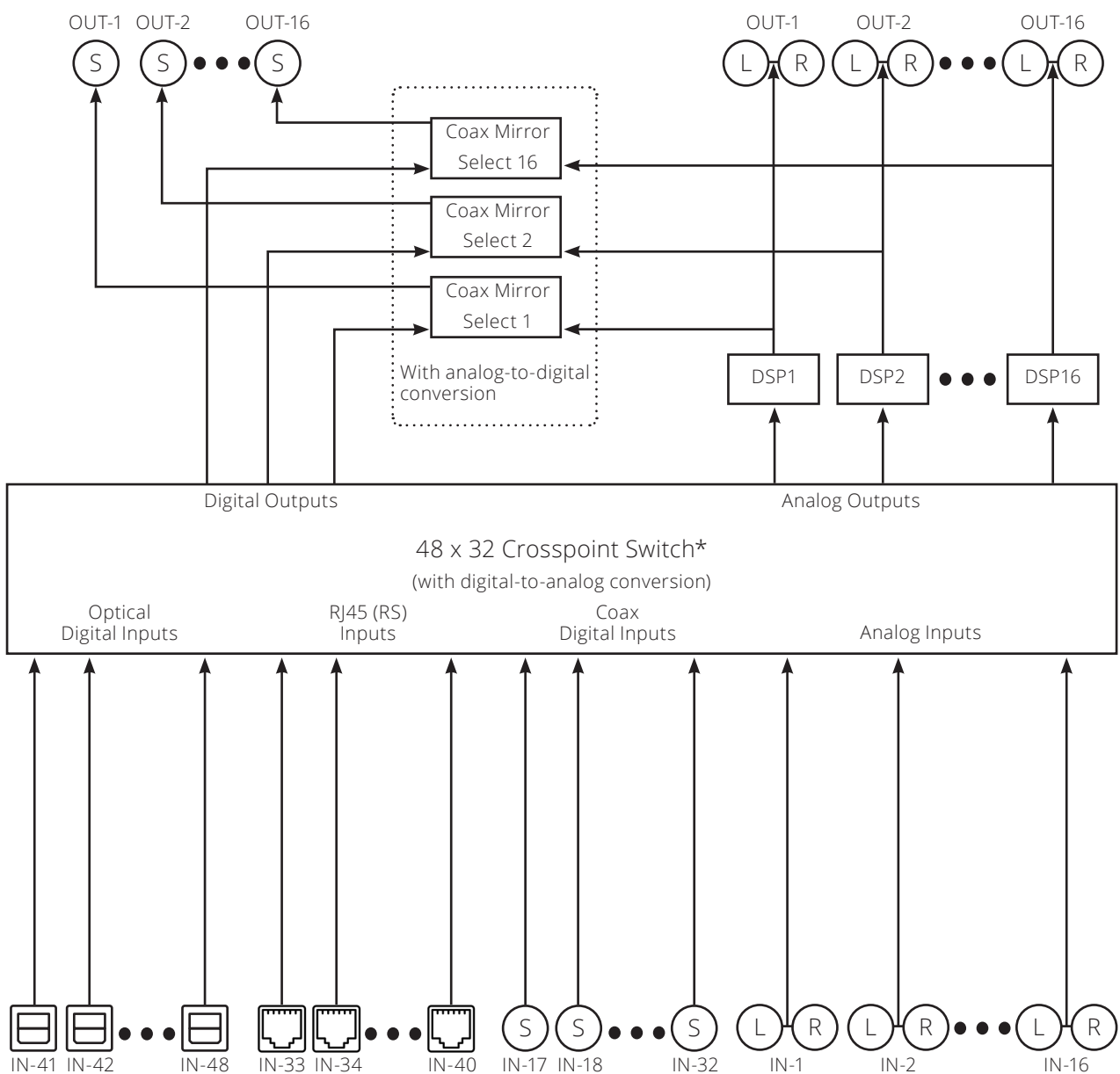

* Only digital 2-channel PCM -to- analog (stereo) conversion is supported. Multichannel downmix is not supported.

IMPORTANT: Outputs can be treated separately or paired together. When paired, analog output 1 is paired with digital output 1, 2 to 2, 3 to 3, etc. By default, analog outputs will be mirrored on the digital coax sides.

INSTALLATION

- The ProAudio16RS features up to 48 independent audio inputs. Connect your local audio source devices directly to the stereo (L/R), coax and optical inputs accordingly.



LEGEND

- ⋯ Infrared
- Cat 5e/6
- Digital Audio
- Analogue Audio
- Ethernet
- Speaker
- HDMI

- Connect your remote audio source devices to the Cat 5e (Remote Source) input.
 - Connect the appropriate category cable (Cat 5e or higher) to each Remote Source (RJ45) input that you require.
 - Complete the connection by attaching the other end of the Cat cable to a supplied AUD-EXT Transmitter 'CAT 5e OUT' port. The AUD-EXT Transmitter should be situated in the remote zone (e.g. next to the TV).
 - Connect COAX or OPTICAL port on the AUD-EXT transmitter to the audio source device (e.g. TV) using the relevant cable.
 - Plug the barrel-to-USB cable to a 5V USB power supply (100mA min).

Note: The 5V power supply is not included. Please ensure to use a power supply capable of providing a stable 5.0V DC /100mA (min). Failure to use a compliant 5V USB power supply may result in AUD-EXT Transmitter damage.

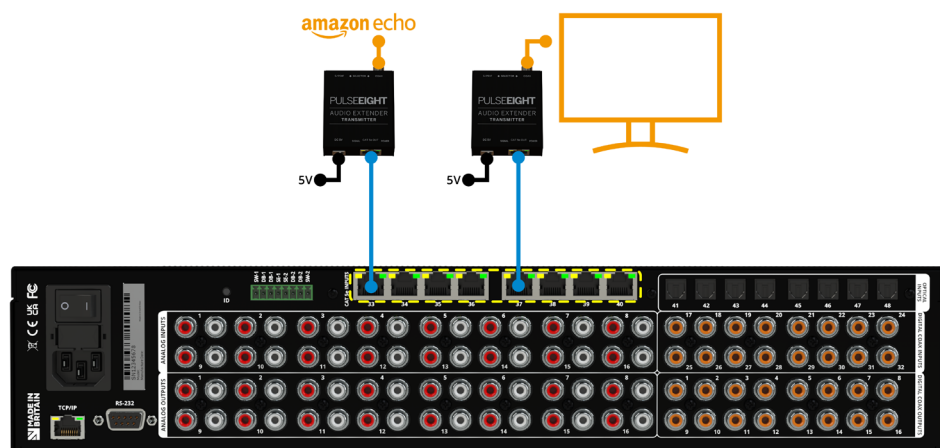

LEGEND

- ⋯ Infrared
- Cat 5e/6
- Digital Audio
- Analogue Audio
- Ethernet
- Speaker
- HDMI

- The ProAudio16RS can have between 16 to 32 audio output zones, depending on your configuration. Connect your audio outputs to the relevant AVR or Audio amplifiers.

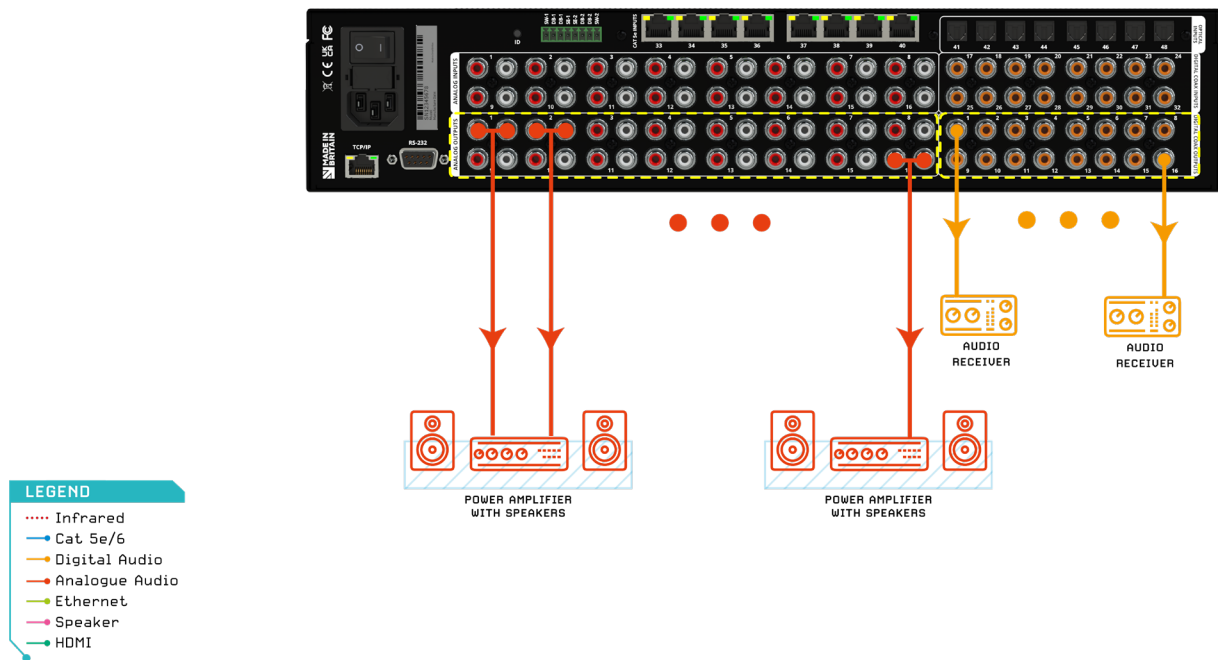

IMPORTANT: If your installation required certain analog input to be converted and routed to digital (coax output), then you will need to mirror the corresponding analog stereo output to do so. Please refer to OVERVIEW - AUDIO ROUTING CAPABILITIES section for more information.

- Connect either the Serial (RS232) or Ethernet connection to your controller.
 Ethernet Connection (recommended): Connect to the local Ethernet using the ProAudio's TCP/IP port.
 Serial Connection: Connect a serial cable between the controller and the ProAudio's RS232 port.

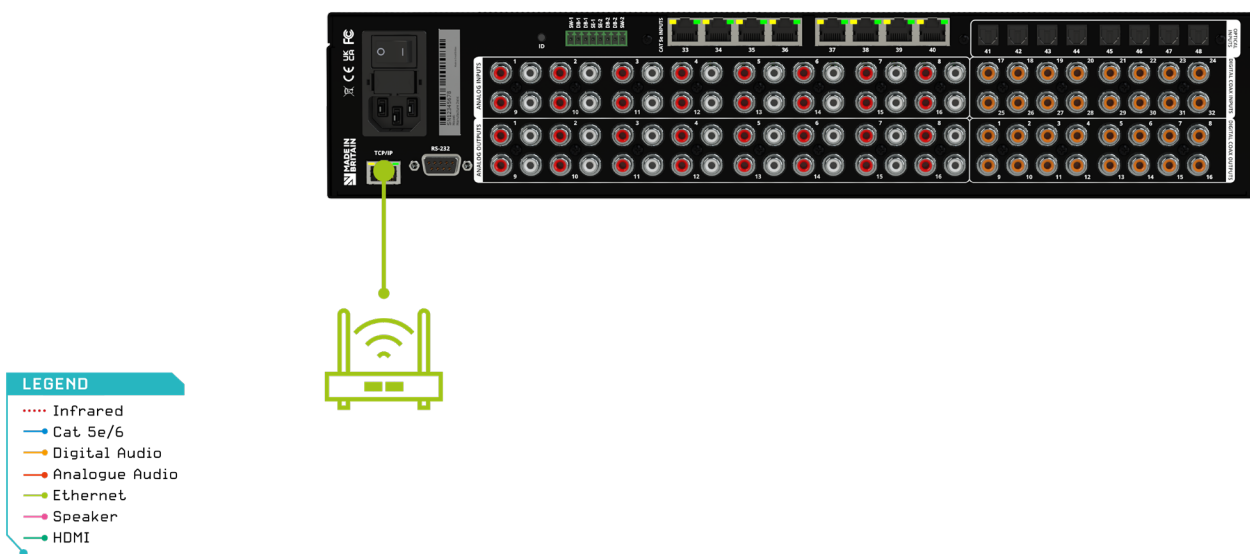

- Connect the power using the included IEC cable.
The unit will take 15-30 seconds to boot up and get an IP address, if using the Ethernet port.

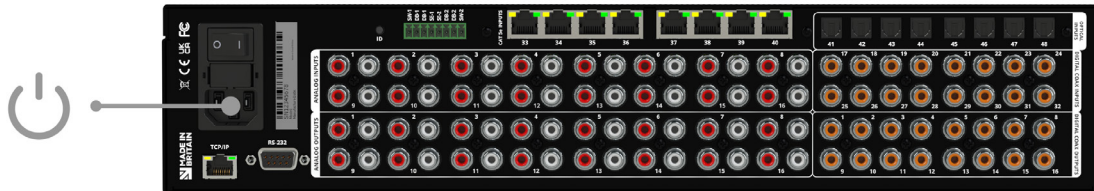

Note: After boot up, please check the LEDs on the front of the system, as described on the **PANEL DESCRIPTIONS** section.

- Link to third-party control system.
Access the Pulse-Eight Cloud Monitoring site to download the necessary drivers. Follow the installation instructions in the driver documentation for that control system.
To access the monitoring portal please visit monitoring.pulse-eight.com, click 'Login' in the top left corner, and sign in with your registered details.
Once logged in, the dashboard will display your details including your Installer ID.

Note: If you do not already have an Installer ID, you'll need to create one. Please contact our customer service team at cs@pulse-eight.com or go to monitoring.pulse-eight.com/Account/Register.

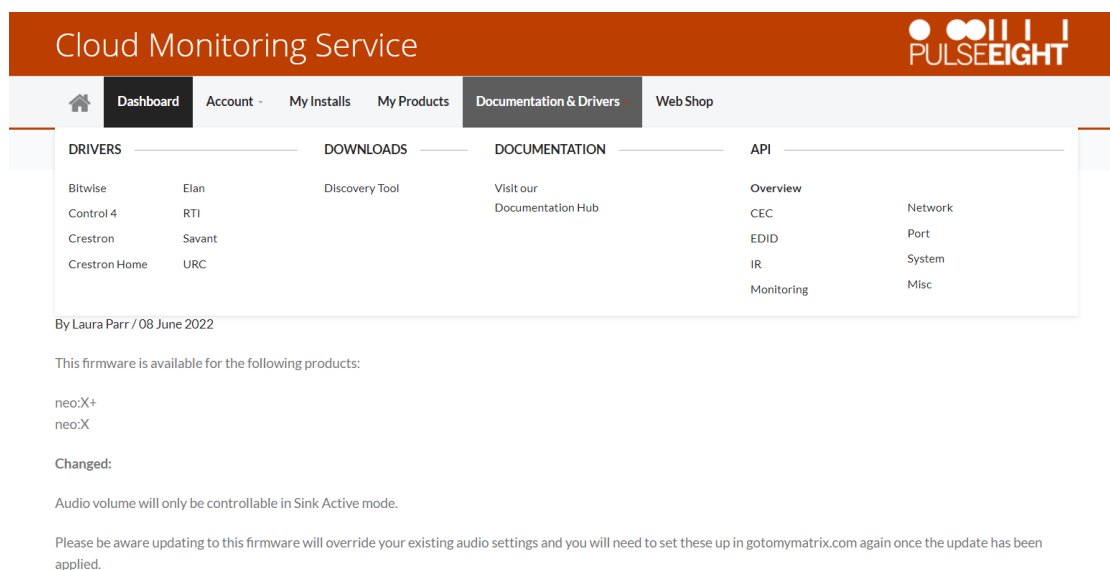

Cloud Monitoring Service 

Dashboard Account My Installs My Products Documentation & Drivers Web Shop

DRIVERS	DOWNLOADS	DOCUMENTATION	API
Bitwise	Discovery Tool	Visit our Documentation Hub	Overview
Control 4			CEC
Crestron			EDID
Crestron Home			IR
			Monitoring
			Network
			Port
			System
			Misc

By Laura Parr / 08 June 2022

This firmware is available for the following products:

neo:X+
neo:X

Changed:

Audio volume will only be controllable in Sink Active mode.

Please be aware updating to this firmware will override your existing audio settings and you will need to set these up in gotomymatrix.com again once the update has been applied.

Alternatively, if you do not have a third-party control system (or driver is not available), please refer to the Control Setup section.

WIRING DIAGRAM

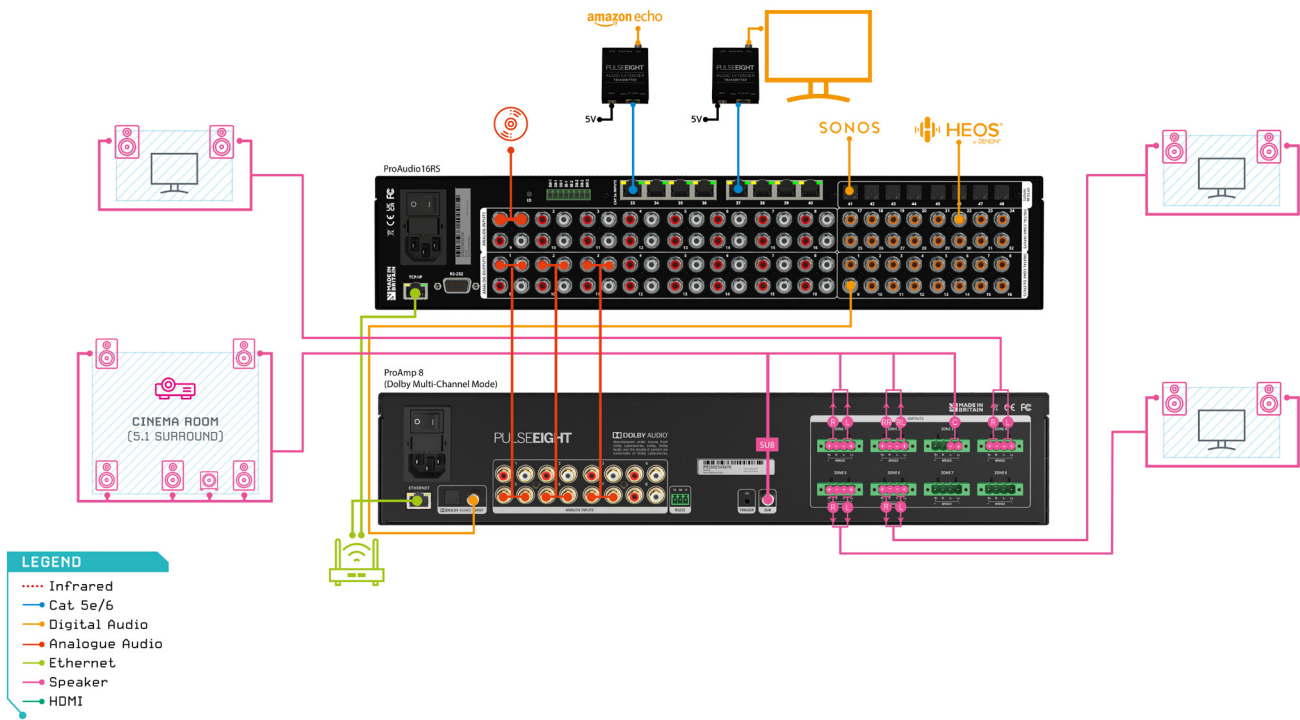

Example of a ProAudio16RS wiring with an amplifier (e.g. ProAmp8).

CONTROL SETUP

ProAudio can be configured using third-party controllers such as Control4, ELAN, and Savant. On the back of the unit, there is an ID button that allows you to configure it directly with Control4. For more information please download the relevant driver and documentation from the Pulse-Eight Cloud Monitoring.

Alternatively, ProAudio also provides a direct configuration method via Command Line Interface (CLI). To use CLI, connect directly to the RS232 port OR use an Ethernet cable with the other end connected to a computer, preferably one running Windows and with access to its communication ports.

Configuring Using Command Line Interface

If you are not using a third-party control system, you can control the ProAudio product with your favourite terminal programme.

PuTTY, for example, is a well-known open source terminal programme. You may already have a copy of this programme on your PC; if not, it can be downloaded at: <https://www.chiark.greenend.org.uk/~sgtatham/putty/latest.html>

Please refer to the ProAudio Universal Protocol Guide.

Using The Serial Port

To use a serial port, you must have a USB to Serial port straight through cable. The ProAudio has a female RS-232 connector, but the USB cable connector must have male pins. When a USB cable is plugged in, Windows will assign a COM port. Determine the COM port of the USB cable using Windows' Device Manager. It's usually between COM3 and COM6, but it can be any number Windows chooses. Then follow these steps:

1. Choose 'Serial' as the Connection type.
2. Then, enter the COM port at the Serial line.
3. The baud rate is 19200. Enter the baud rate at the Speed.
4. After setting up the COM port and baud rate click on 'Terminal'.
5. Go to the "Setting Up The Line Control Option" section, as this is required.

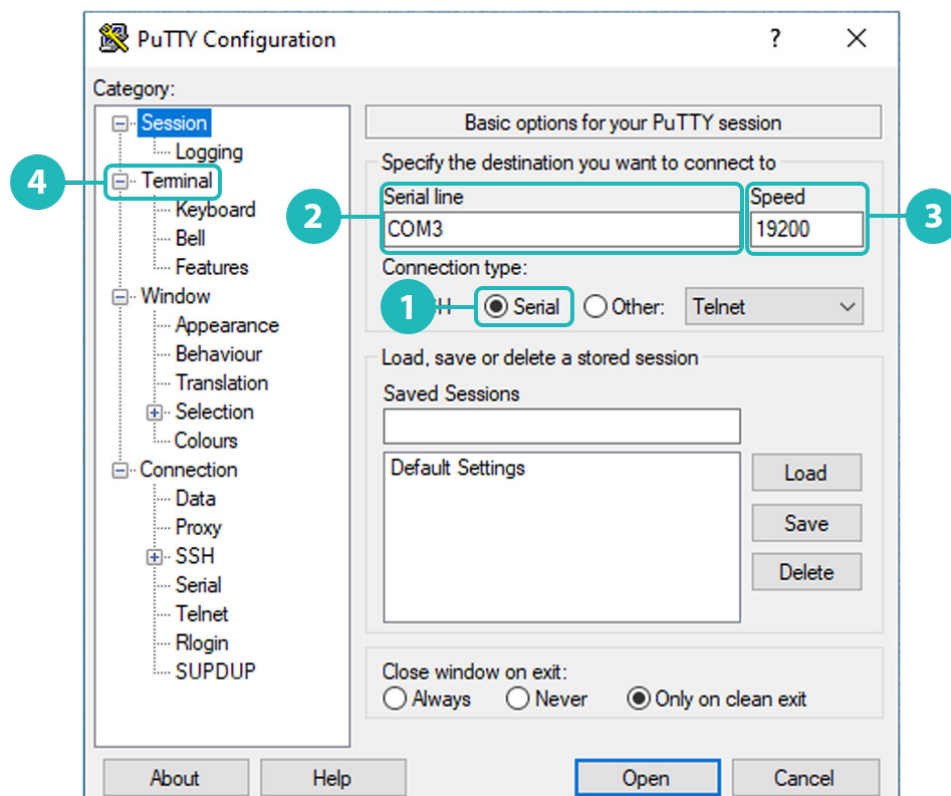

Using TCP/IP

To use TCP/IP, you must first search the network for the IP address of the ProAudio. Depending on when the ProAudio was made, the MAC address will be listed under Zektor or Pulse-Eight.

The MAC address will either begin with 5C.D4.AB.xx.xx.xx or 00-15-82-xx-xx-xx.

Once the IP address is known. Then follow these steps:

1. Choose 'Raw' as the Connection type.
2. Then, enter the IP address/MAC address at the Host Name.
3. Enter the 50005 at the Port.
4. After entering the IP address and port number click on "Terminal". Then, go to the "Setting Up The Line Control Option" section, as this is required.

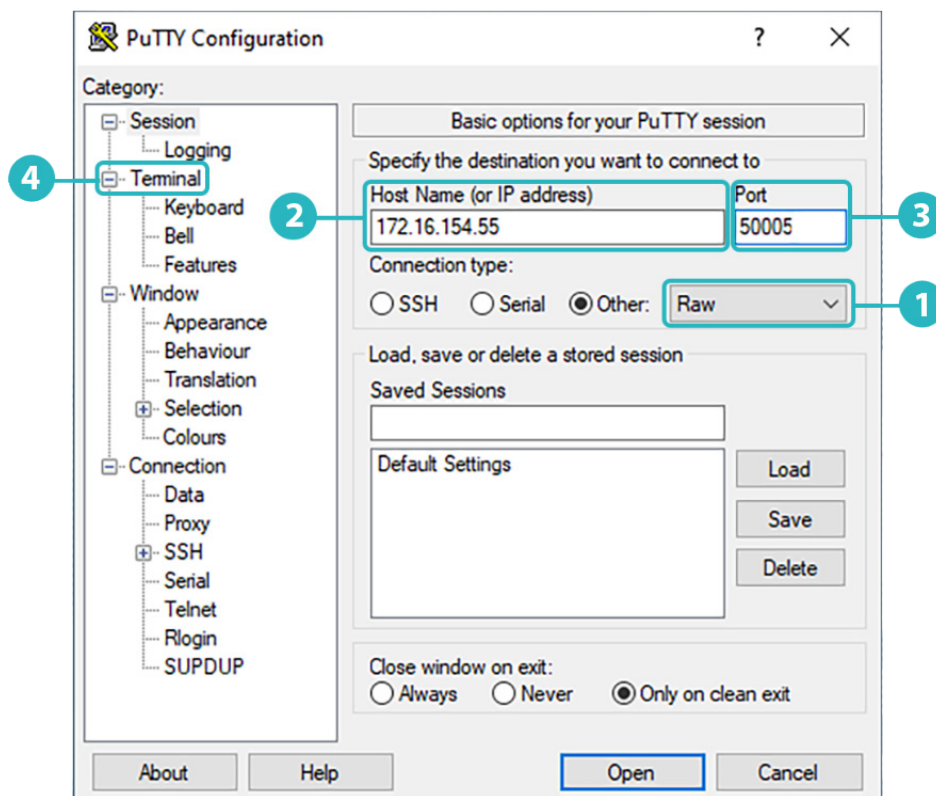

Setting Up The Line Control Options

5. Set them to "Force on" this allows you to see what you are typing, and to edit it before sending.
6. After the two options are selected, press the "open" button, and the command window should open up.

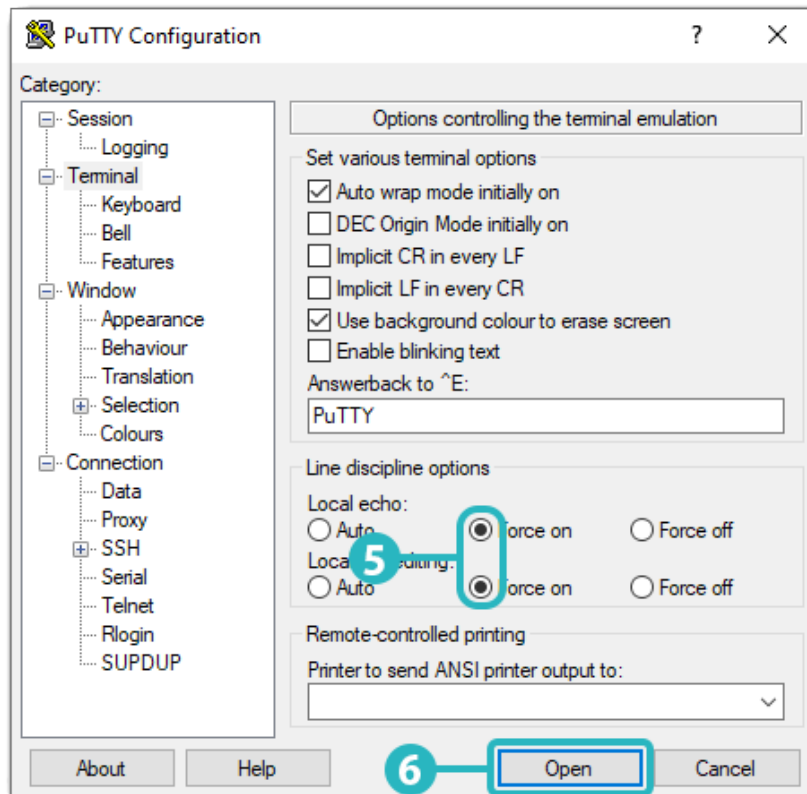

Testing The Connection

7. To see if a connection has been established, enter the version command: `^V$` and then press enter. The terminal program being used (e.g. PuTTY), will then send the response showing the model switch that is connected as shown in the image. The unit should report back the following:

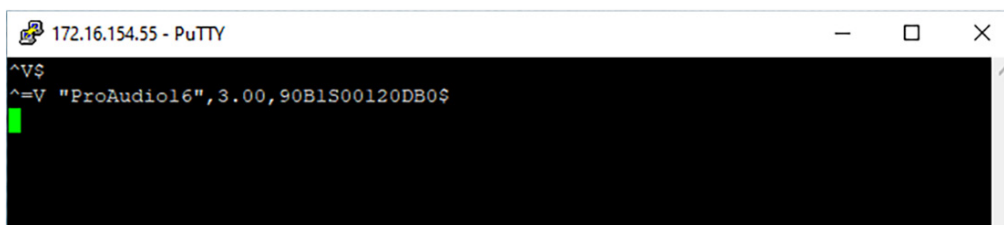

<Model of ProAudio> , <Software version>, <internal serial number>

Please note that the internal serial number should not be used for support queries.

For more information, including list of API commands, please refer to the ProAudio Universal Protocol Guide.

PAGING AND DOORBELL

The back panel can be wired to accept dry contact closures (for push buttons or relay triggers), or voltage triggers. You can mix connection types and setup one connection for dry closures, and the other for voltage triggers.

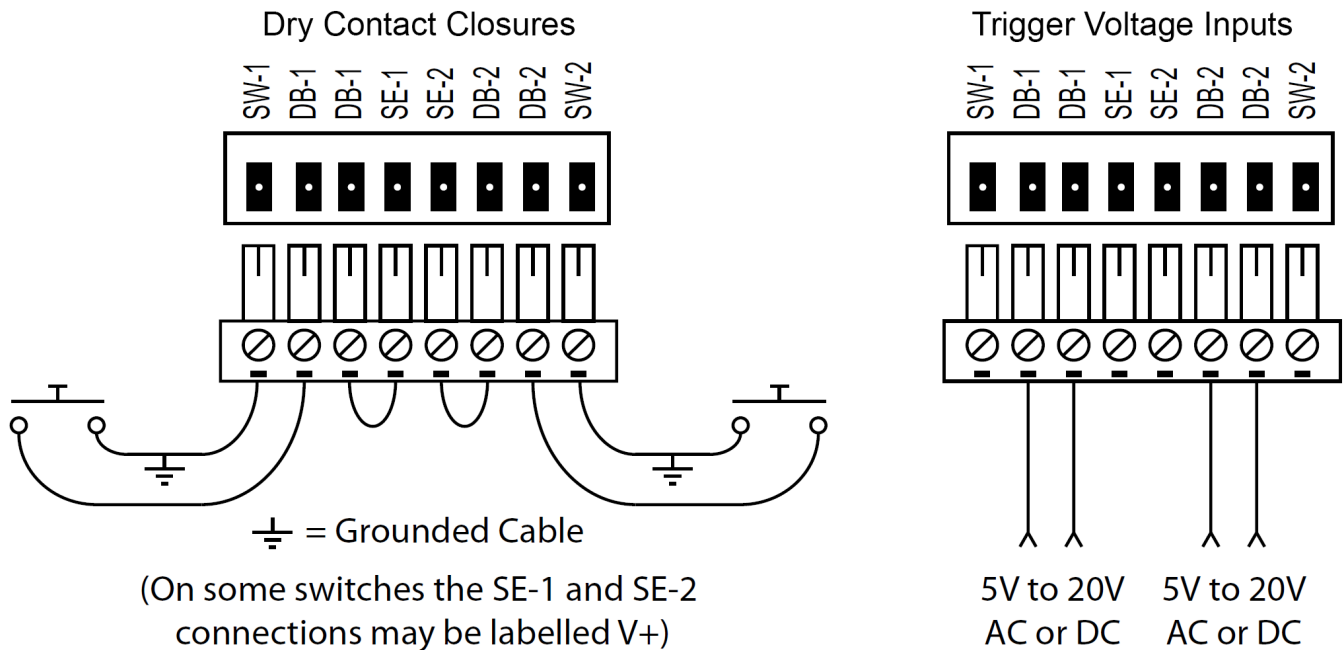

To use dry contact closures, add a jumper between the SE and dB connections, and connect the switch to other dB input and the SW input. Note that the SW-1 and SW-2 connections are also connected to the chassis ground. If you are using a shielded cable to the switch, connect the SW side to the shield. If one side of your button is grounded, the side that is grounded should use the SW connection.

The voltage trigger inputs can be wired directly to the doorbell transformer, so that when the doorbell rings, paging will also occur. When used in this manner, the doorbell system can be setup to mute or lower the volume of the audio during a doorbell press, to allow the doorbell to be heard.

HOW DO I SETUP THE PAGING SYSTEM?

When a page or doorbell is triggered (from now on just referred to as a "page"), all the zones switch to a predetermined source, and a predetermined volume. When the page is finished, all the zones are restored to their normal operation.

There are two page settings, with their own setups. For instance 'page 1' could be used for the front door, and 'page 2' for the back door. If you have two different sound generators, then you could have a different sound for the two doorbells, and setup the pages to be connected to two different sources.

To make all this work, the installers need to set up, in advance, all the things each zone should do when a page is triggered. This can be done by sending the correct commands over the serial or TCP/IP port.

Please refer to your control driver documentation or please refer to the ProAudio Universal Protocol Guide, depending on your control setup.

AUDIO OUTPUT ZONE SETTINGS

The ProAudio16RS offers several parameters that can be individually set for each output port (zone).

The following parameters can be adjusted per output port:

- **Volume:** Range from +24dB to -99.5dB, and full mute (-115dB), in 0.5dB step resolutions.
- **Balance:** Range from -200 (full left) to +200 (full right) in 0.5 dB steps.
- **Treble:** Range from -20dB to +20dB, in 0.5dB steps
- **5-Band Equalizer:** Set at 100Hz, 330Hz, 1,000Hz, 3,300Hz and 10,000Hz. Each EQ band setting can range from -20dB to +20db, in 0.5dB steps.
- **Stereo to Mono Mix:** If required, the stereo inputs can be mixed in a number of ways.
- **Lock Zone:** It can be set so that the selected audio output to be locked to another zone.
- **Subwoofer Settings (Filter/Frequency):** When using a subwoofer, you can set the sub filter to 12dB or 24dB, and the sub crossover frequency to be anything between 50-300Hz.
- **Lip Sync:** Can set a delay to the output. Range between 0-170.65 ms, in 1/48 ms steps.
- **Coax Port:** Enable the Coax port to mirror the stereo (analog) port, or to be independent.
- **Paging Settings:** Set actions that each zone should take when a page.

For more information, please refer to “**CONFIGURE PROAUDIO OUTPUTS**” section on your control driver documentation. Alternatively, refer to the ProAudio Universal Protocol Guide when not using a third-party control system.

LOCK ZONE

The ProAudio16RS has “Zone Lock” capabilities for all of its audio outputs.

The Zone Lock feature allows you to:

- Make an audio output zone always switch to the same source as a different output zone
- Send volume to one output zone and have another zone go to the same volume
- Or, when using a subwoofer, it can make the subwoofer (connected to the audio output zone) switch to the same source as the smaller speakers

Every audio output has a “Lock Zone” parameter that can be set to follow another zone.

For instance, if you have a set of stereo speakers connected to output 1 (zone 1), and a subwoofer connected to output 2 (zone 2), then you would set zone 2 to use “Lock Zone” parameter to lock it to output 1. Now each time zone 1 changes sources, zone 2 will also change sources. When the volume is raised on zone 1, zone 2’s volume will also be raised.

More than one zone can be locked onto the same zone. For instance, after the above zone is setup (i.e. zone 2 is locked to zone 1), then Audio Output 3 (zone 3) can be set to lock to zone 1. Now each time zone 1 changes sources, both zones 2 and 3 will also change sources. When the volume is raised on zone 1, then the volume for zones 2 & 3 will also be raised.

Please note that not all things are locked between the outputs, here’s the list of locked parameters:

- Volume (including other volume related parameters like Mute)
- Bass and Treble (but not the equalizers)
- Source changes

Anything not listed above, is not locked. Notable things that are not locked are:

- Equalizers, this allows using different setting for a subwoofer than for the stereo set.
- Output Level, this allows adjusting the level of a subwoofer independent of the stereo speakers.
- Lip Sync Delay, this allows a delay to be set to compensate for distances between the subwoofer and speakers.

Caveats:

Care must be taken to avoid a zone following itself; for example, if zone 2 and zone 3 follow zone 1, but zone 1 follows zone 3, this will not work because zone 1 is following itself. Zone 1 in this example cannot be followed by any other zone.

If you accidentally set a zone to follow itself, all zones that follow it will revert to the unlock mode.

For more information, please refer to your control driver documentation.

SETTING UP A SUBWOOFER

Each zone has a crossover filter that can allow only high frequencies, or only low frequencies to pass, or be disabled (and allow all frequencies to pass).

Both the crossover type and the crossover frequency has to be set before the crossover filter is enabled. This can be done by selecting the correct “crossover filter” parameter for both the subwoofer and main speaker zone outputs.

Note: The default is to set “24dB/oct Low Pass Filter” for the subwoofer zone and “24dB/oct High Pass Filter” for the main stereo speakers zone.

The 12dB / 24dB is the sharpness of the filter, how fast it cuts off high or low frequencies. Experimenting with this setting and listening for what sounds best is encouraged.

Then the “crossover frequency” parameter are to be set for both the subwoofer and main speaker zone outputs.

Note: Both the main speakers and the subwoofer should be set to the same frequency. When going up in frequency, this setting indicates the frequency the subwoofer stops working and the main speakers take over. This value is usually between 100Hz and 150Hz, but we allow values between 50 and 300Hz.

Again, experimenting with this setting and listening for what sounds best is encouraged.

For more information, please refer to your control driver documentation.

SETTING MINIMUM/MAXIMUM VOLUME

The output's "min volume" and "max volume" settings are the absolute volume levels. A volume level of 0 means that the signal level coming into the switch is the same as the signal level going out. Each step of one of the settings is a 0.5dB change. So a setting of 1 = +0.5dB gain, and -1 = -0.5dB loss.

So the default values are 24 = 12.0dB gain, and -120 = -60dB loss.

The gain command is given in 0.5dB steps and uses an offset of 200 to indicate a gain of 0.0dB. Values above 200 raise gain, and values below 200 lower gain.

The minimum and maximum volume settings must have at least a 49.5dB (99 steps) difference between them. Any attempt to set the maximum volume closer than 99 steps of the minimum, will result in a setting of exactly 99 steps above the minimum volume setting.

The use of the Max Volume is pretty straight forward. Any user of the switch cannot set the level above Max Volume, this can be used to limit volumes at specific zones.

The Min Volume use is more subtle. If you are in a quiet room, you can turn down the volume and still hear audio way down into whisper levels. In a case like this you would set the Min Volume to a large negative value, since this will allow you to turn the volume way down.

If you have speakers in the backyard, you might not hear much once you turn the speakers below 50% because of all the background noise, this is irritating because now half the volume is wasted, once you get below 50% nothing happens. And if the volume level starts all the way down at 1%, it can feel like it's not working as you hold the volume button down between 1% and 49%, waiting to hear something. In this case like this, you can turn the Min Volume up until you can actually start to hear something at around 5% or so. Now you have the complete range of the volume control from 1% to 100%, and the sound fades out below 5% like it should.

For more information, please refer to your control driver documentation.

FIXED AUDIO OUTPUT

There might be occasions when the volume control on the switch needs to be disabled, such as when using an AVR as an amplifier.

To do so, select the Audio Output of the zone you're interested in setting up, then set the volume to 84%. Note that 84% is the pass through level (if the Min and Max default volume settings have not been changed). It sets the volume so that the level going out is the same as the level coming in.

To keep the volume from changing, make sure you don't use the audio switch as the volume endpoint for the zone being setup. In the AVR example, the AVR should be the volume endpoint, not the audio switch.

TROUBLESHOOTING

Should you encounter installation difficulties or issues with device communication, the following checklist of common issues and causes should help resolve your issues. If you still continue to experience issues, please contact your local representative or Customer Support team (cs@pulse-eight.com) for further assistance.

No Audio

- Cable quality and condition - cable/connectors can easily be damaged and the quality of material can vary. Always use good quality leads and cables and try swapping cables that are known to be working into the solution to see if this improves your output.
- Volume - check that the selected audio output is not set to full mute or a very low volume.
- Amplifier - confirm that the connected audio amplifier and speakers are working as expected.
- Output routing and settings - make sure that the audio output is routed to the desired audio input.
- Digital output - when using the coax output, please ensure that the attached AVR/amplifier supports 5.1/3.1 multichannel audio and 2ch PCM audio.

“Paging” Not Triggering

- When setting up the paging it is important to ensure that the dry contacts or triggers are wired up correctly. Please check against the wiring shown in the PAGING AND DOORBELL section.
- Have you set up the specified output port “paging” settings on your control system correctly? As each output port needs to be set up individually, it is important to ensure that if any issues arise, that the settings are double-checked as it is easy to make a mistake when setting several of the outputs to support paging functionality.

Subwoofer Not Working

Have you set the subwoofer output port correctly? It is important that the output port for the subwoofer is LOCKED to the output port that the stereo speaker (Front-Left/Front-Right) are connected to. Check that the crossover frequency is set to between 100Hz and 150Hz to begin with for testing. See SETTING UP SUBWOOFER section.

Hear A Low “Humming/Buzzing Noise”

On the rare occasion when there might be a low, humming or buzzing noise coming from the speakers in your installation, the causes could be poor cabling, other equipment in the setup (e.g. amplifier), possible “ground loop” feedback noise on the RCA cables or on the AC mains.

- First, check that the cables are all of good quality and maybe consider replacing them if you notice that they have an effect.
- Secondly, verify that the amplifier and speakers do not cause this humming noise on their own when disconnected from the ProAudio.
- If neither of the above resolves the issue, then the problem might be “ground loop” noise and it is worth consider replacing the standard RCA connectors (from ProAudio to amplifier) with a “ground isolator” adapter RCA cable. It is also worthwhile considering adding an isolating transformer or a “DC blocker” on the AC power input of the equipment.

MANUAL VERSION HISTORY

V1.0 - 21st July 2022. First Version.

V1.1 - 28th June 2023. Added input and Output voltage in Specification section. Included Revision History section. Update Overview - Audio Routing Capabilities diagram.

WARRANTY PROCEDURE

The following policies covers all Pulse-Eight products.

Unless otherwise instructed, please do not open any of our products. Doing so will invalidate your warranty. As part of the troubleshooting procedure, you may be instructed to open the device, but you can only proceed with this once consent has been given.

To open a support ticket, please visit: www.pulse-eight.com/support.

Please Note: Warranty cover for ALL products starts from date of receipt of goods NOT date of installation. Should we find that your product does need replacing, we will send your replacement directly to the distributor you purchased from, if not purchased directly from Pulse-Eight.

From 1st April 2022, any products purchased will have new warranty lengths. The length of warranty is determined by the type of product purchased. Our cover can be broken down into 3 categories:

Gold, Silver, and Bronze.

GOLD: Pulse-Eight Audio and Video Matrices

- 5-year warranty as standard
 - 3-year advanced replacements
 - 2-year return to base for repair

SILVER: Pulse-Eight Amps, Extender Sets, and Accessories

- 3-year warranty as standard
 - 1-year advanced replacements
 - 2-year return to base for repair

BRONZE: IR, Cables, Brackets, and our Tech Tools

- 1-year advanced replacements

Pulse-Eight Current Product—Within the advanced replacement warranty year(s)

1. Contact support via phone or a support ticket. Pulse-Eight will try to help troubleshoot and resolve the issue remotely.
2. If unable to resolve the fault remotely and the unit needs replacing an advanced replacement will be raised with the installer who purchased it. If you purchased from a distributor you will need to return to your distributor and they will contact Pulse-Eight to get the RMA raised. All distributor advanced replacements will be sent to the distributor and cannot be sent directly to their installer.

Pulse-Eight Current Product—Within return to base warranty

1. Contact support via phone or a support ticket. Pulse-Eight will try to help troubleshoot and resolve the issue remotely.
2. If unable to resolve the fault remotely and the unit needs to be repaired, an RMA will be raised with the installer if purchased direct from Pulse-Eight. Or if purchased from a distributor, the installer will be directed back to their distributor who will raise an RMA.

Pulse-Eight Products Purchased Before 1st April, 2022.

Please visit: [Warranty Page](#). Or Contact support via phone, opening a support ticket or emailing support@pulse-eight.com.

WARRANTY TERMS & CONDITIONS

IMPORTANT INFORMATION ABOUT YOUR RIGHTS AND OBLIGATIONS, AS WELL AS LIMITATIONS AND EXCLUSIONS THAT MAY APPLY TO YOU. YOUR RIGHTS AND THIS LIMITED WARRANTY

This Limited Warranty gives you specific legal rights. You may also have other legal rights that vary by state, province, or jurisdiction. The disclaimers, exclusions, and limitations of liability under this Limited Warranty will not apply to the extent prohibited by applicable law. For a full description of your legal rights, you should refer to the laws applicable in your jurisdiction and you may wish to contact a relevant consumer advisory service.

1. WHAT THIS LIMITED WARRANTY COVERS; PERIOD OF COVERAGE

Pulse-Eight Limited ("Pulse-Eight"), 8-12 Alder Hills, Poole, BH12 4AL, UK, warrants to the owner of the enclosed product that the product contained in this box ("Product") will be free from defects in materials and workmanship for a period of three years from the date of delivery following the original purchase (the "Warranty Period"), or if this product has been professionally installed, the warranty start date is from the date your installer purchased the item, not your system commissioning date. Please check with your installer for their purchase date. If the Product fails to conform to this Limited Warranty during the Warranty Period, Pulse-Eight will, at its sole discretion, either (a) repair or replace any defective Product or component; or (b) accept the return of the Product and refund within 45 days of return the money actually paid by the original purchaser for the Product. Repair or replacement may be made with a new or refurbished product or components, at Pulse-Eight's sole discretion.

If the Product or a component incorporated within it is no longer available, Pulse-Eight may replace the Product with a similar product of similar function, at Pulse-Eight's sole discretion. This is your sole and exclusive remedy for breach of this Limited Warranty. Any Product that has either been repaired or replaced under this Limited Warranty will be covered by the terms of this Limited Warranty for the longer of ninety (90) days from the date of delivery or the remaining Warranty Period. This Limited Warranty is transferable from the original purchaser to subsequent owners, but the Warranty Period will not be extended in duration or expanded in coverage for any such transfer.

2. TOTAL SATISFACTION RETURN POLICY

If you are the original purchaser of the Product and you are not satisfied with this product for any reason, you may return it in its original condition within thirty (30) days of the original purchase and receive a full refund. If this is a professionally installed product, you must check with your installer regarding their own returns policy.

3. WARRANTY CONDITIONS; HOW TO GET SERVICE IF YOU WANT TO CLAIM UNDER THIS LIMITED WARRANTY

Before being able to claim under this Limited Warranty, the owner of the Product must (a) notify Pulse-Eight of the intention to claim by emailing support@pulse-eight.com during the Warranty Period and providing a description of the alleged failure, and (b) comply with Pulse-Eight's return shipping instructions, and (c) ship the Product at owner's cost (except where prohibited by applicable law) to Pulse-Eight for repair or replacement. Pulse-Eight will have no warranty obligations with respect to a returned Product if it determines, in its reasonable discretion after examination of the returned Product that the Product is an Ineligible Product (defined below). Pulse-Eight will bear all costs of return shipping to the owner, except with respect to any Ineligible Product, for which the owner will bear all shipping costs.

4. WHAT THIS LIMITED WARRANTY DOES NOT COVER

This warranty does not cover the following (collectively "Ineligible Products"): Products marked as "sample" or sold "AS IS"; or Products that have been subject to: (a) modifications, alterations, tampering, or improper maintenance or repairs; (b) handling, storage, installation, testing, or use not in accordance with the Installation Guide or other instructions provided by Pulse-Eight; (c) abuse or misuse of the Product; (d) breakdowns, fluctuations, or interruptions in electric power or the telecommunications network; or (e) Acts of God, including lightning, fire, flood, tornado, earthquake, or hurricane. This warranty does not cover consumable parts, including batteries unless damage is due to defects in materials or workmanship of the Product, or software (even if packaged or sold with the product). Pulse-Eight recommends that you use only authorized service providers for maintenance or repair. Unauthorized use of the Product or software can impair the Product's performance and may invalidate this Limited Warranty. Pulse-Eight does not warrant that operation of the Product will be error-free or uninterrupted or that the Product will in every case process all data correctly.

5. DISCLAIMER OF WARRANTIES

Except as stated above in this limited warranty, and to the maximum extent permitted by applicable law, Pulse-Eight disclaims all express, implied, and statutory warranties and conditions with respect to the product, including the implied warranties of merchantability, fitness for a particular purpose. To the maximum extent permitted by applicable law, also limits the duration of any implied warranties or conditions to the duration of this limited warranty.

6. LIMITATION OF DAMAGES

In addition to the above warranty disclaimers, in no event will Pulse-Eight be liable for any consequential, incidental, exemplary, or special damages, including any damages for lost data or lost profits, arising from or relating to this limited warranty or the product, and Pulse-Eight's total cumulative liability arising from or related to this limited warranty or the product will not exceed the amount actually paid for the product by the original purchaser.

7. LIMITATION OF LIABILITY

Pulse-Eight disclaims all liability of any kind of Pulse-Eight's suppliers. The Pulse-Eight online services ("services") may provide you with information ("product information") regarding your product's performance and/or peripherals connected to your product ("product peripherals"). The type of product peripherals that may be connected to your product may change from time to time. Without limiting the generality of the disclaimers above, all product information is provided for your convenience, "as is", and "as available". Pulse-eight does not represent, warrant, or guarantee that product information will be available, accurate, or reliable. You use all product information, the services, and the product at your own discretion and at risk. You will be solely responsible for (and Pulse-Eight disclaims) any and all loss, liability, or damages, including to your HVAC system, plumbing, home, product, product peripherals, computer, mobile device, and all other items and pets in your home, resulting from your use of the product information, services, or product. The product information provided by the services is not intended as a substitute for direct means of obtaining the information.

8. VARIATIONS THAT MIGHT APPLY TO THIS LIMITED WARRANTY

Some jurisdictions do not allow limitations on how long an implied warranty lasts or exclusions/limitations on incidental or consequential damages, so some of the limitations set out above may not apply to you.

COPYRIGHT NOTICE

No part of this document may be reproduced, transmitted, transcribed, stored in a retrieval system, or any of its parts translated into any language or computer file, in any form or by any means (electronic, mechanical, magnetic, optical, chemical, manual, or otherwise) without express wrote permission and consent from Pulse-Eight Limited.

© Copyright 2023 Pulse-Eight Limited. All Rights Reserved.

Dolby and Dolby Atmos are either trademarks or registered trademarks of Dolby Laboratories in the United States and/or other countries.

The Adopted Trademarks, HDMI High-Definition Multimedia Interface, HDMI trade dress, and HDMI Logos are trademarks or registered trademarks of HDMI Licensing Administrator, Inc. in the United States and other countries.

Other trademarks, registered trademarks, and trade names may be used in this document to refer to either the entities claiming the marks and names or their products. Pulse-Eight disclaims any proprietary interest in the marks and names of others.

